

# LED Recessed Down light

- IP Rated



Citizen

Bridgelux Vero 10

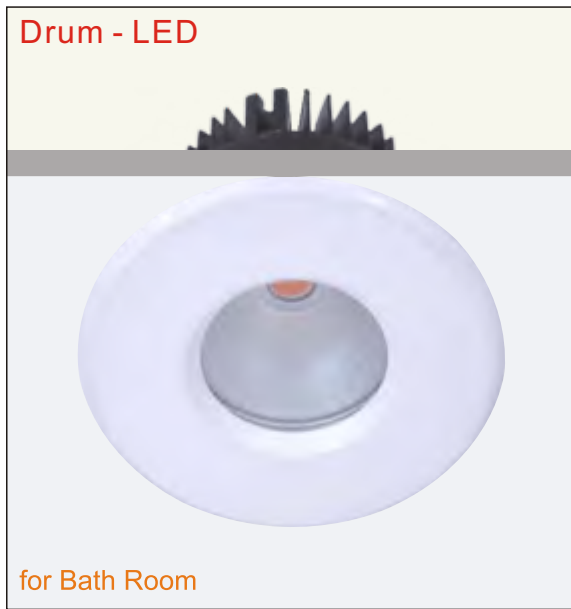

## LD3304

Trim : Alum. Die Cast  
 Housing : Steel Sheet  
 Diffuser : Clear Tempered Glass  
 Reflector : Angle 22°  
 Angle 30°  
 Angle 45°  
 Heat Sink : Alum. Extrusion  
 LED Power : Citizen 9W / 13W  
 Version : Bridgelux Vero 10



Application : Bath Room & Kitchen

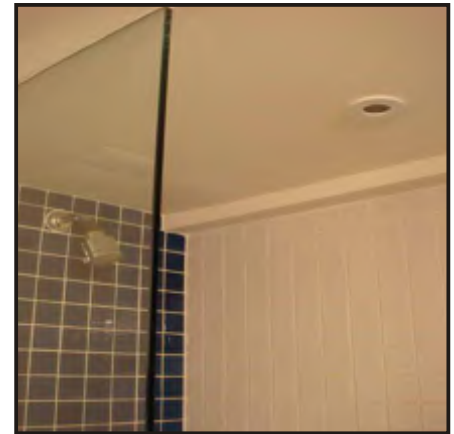
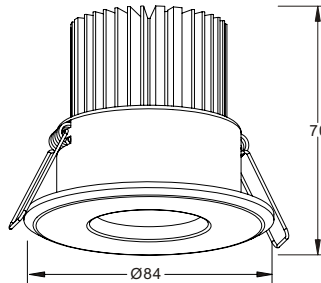

Intensity(unit:cd)

Citizen 13W

$\theta$  av( $\frac{1}{2}$ ): 45°

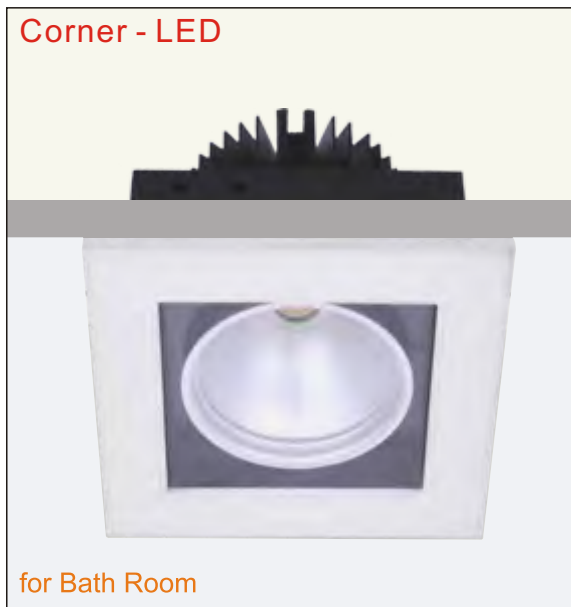
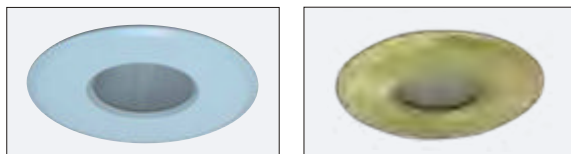
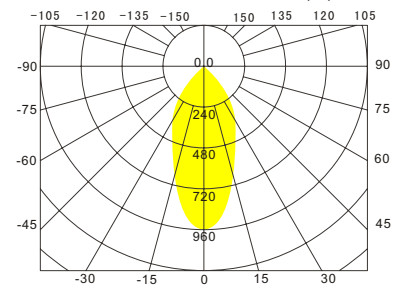

## LD3404

Trim : Alum. Die Cast  
 Housing : Steel Sheet  
 Diffuser : Clear Tempered Glass  
 Reflector : Angle 22°  
 Angle 30°  
 Angle 45°  
 Heat Sink : Alum. Extrusion  
 LED Power : Citizen 13W  
 Version : Bridgelux Vero 10



Application : - Bath Room  
 - Kitchen  
 - Hotel  
 - Commercial Area

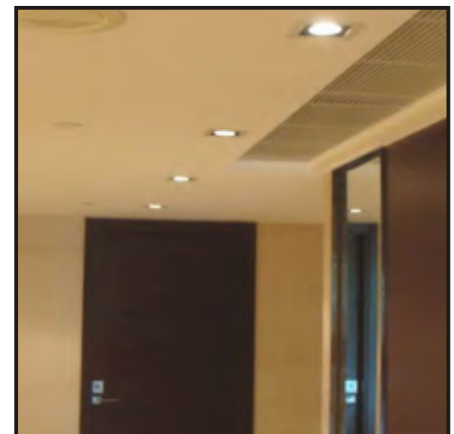
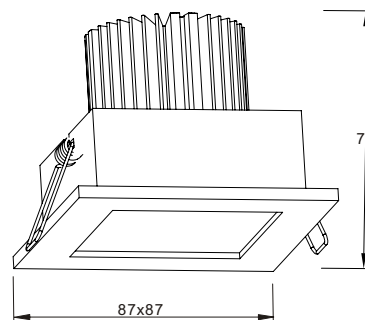

Intensity(unit:cd)

Citizen 13W

$\theta$  av( $\frac{1}{2}$ ): 45°

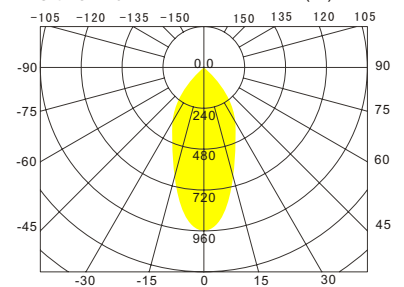

# LED Recessed Down light

## - Fixed Angle

Application :  
Retail, showroom, hotel, gallery & interior project

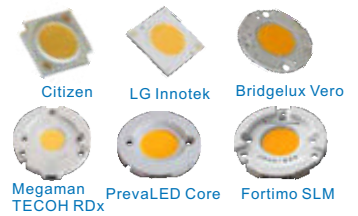

**Victoria**

### LD220

Trim : Alum. Die Cast  
Diffuser : Clear Glass / Frosted Glass  
Housing : Alum. Die Cast  
Reflector : Angle 22°, 30°, 45°  
LED Power : Citizen 13W  
Version : Bridgelux Vero 10

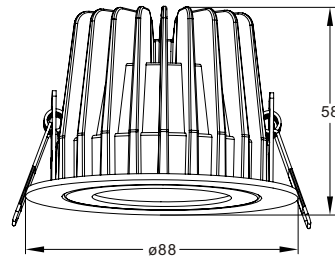
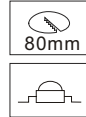

### Intensity(unit:cd)

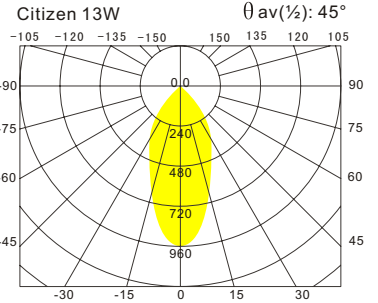

**Pillar-S**

### LD306

Trim : Alum. Die Cast  
Reflector : Angle 10°, 24°, 36°  
Diffuser : Clear Glass / Frosted Glass  
Housing : Steel, Black Painted  
Heat Sink : Alum. Extrusion  
LED Power : Citizen 13W  
Versions : Bridgelux Vero 10  
PrevaLED Core Z3 1100lm  
LG LEMWM11 28W  
Megaman TECOH RDx

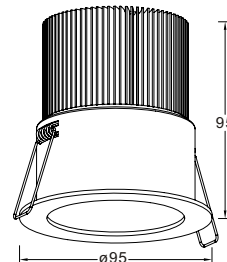

### Intensity(unit:cd)

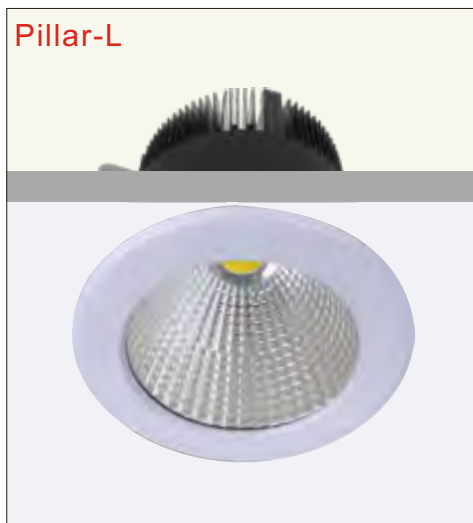
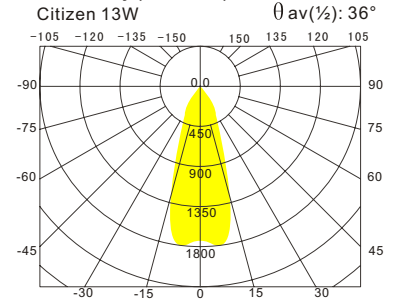

**Pillar-L**

### LD6900

Trim : Alum. Die Cast  
Reflector : Angle 10°, 29°, 47°  
Diffuser : Clear Tempered Glass  
Housing : Steel  
Heat Sink : Alum. Extrusion  
LED Power : Citizen 28W  
Versions : Bridgelux Vero 13  
Fortimo SLM 2000lm  
PrevaLED Core Z3 2000lm  
LG LEMWM11 28W  
Megaman TECOH RDx

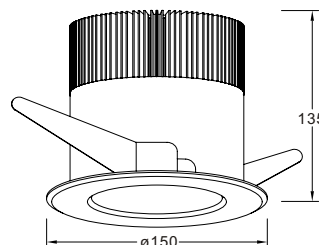
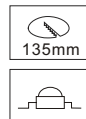

### Intensity(unit:cd)

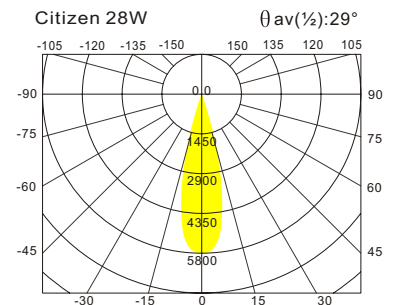

### LDW6900

# LED Recessed Down light

**- Adjustable**

Application :  
Retail, showroom, hotel, gallery & interior project



## LD2711

Outer Trim : Alum. Die Cast  
Inner Trim : Alum. Turning  
Reflector : Angle 22°, 30°, 45°  
Diffuser : Clear Glass / Frosted Glass  
Heat Sink : Alum. Extrusion  
LED Power : Citizen 13W  
Version : Bridgelux Vero 10

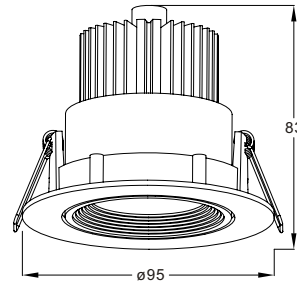

## Intensity(unit:cd)

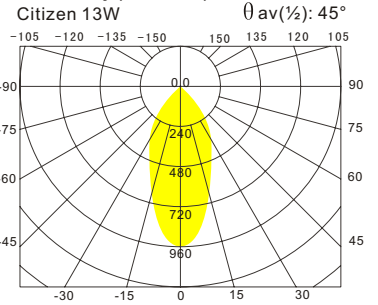

## LDW308

Outer Trim : Alum. Die Cast  
Inner Trim : Alum. Turning  
Reflector : Angle 10°, 24°, 36°  
Diffuser : Clear Tempered Glass  
Heat Sink : Alum. Extrusion  
LED Power : Citizen 13W  
Versions : Bridgelux Vero 10  
PrevaLED Core Z3 1100lm

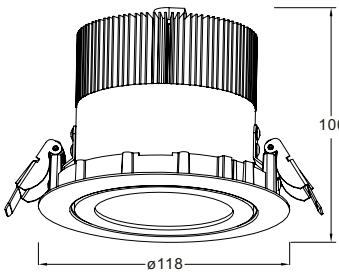

## Intensity(unit:cd)

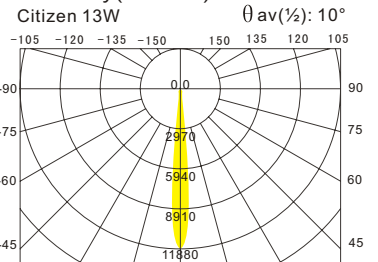

Suitable for 2201 reflector



## LDW308-XSM

Trim : Alum. Die Cast  
Reflector : Angle 22°, 30°, 40°  
Housing : Alum. Extrusion Turning  
Heat sink : Alum. Extrusion  
LED Power : Xicato XSM 1100lm / Xicato XSM 1300lm

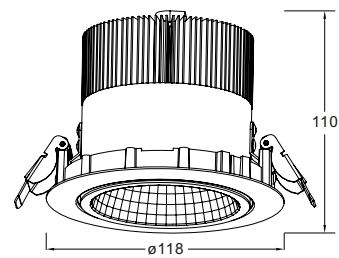

## Intensity(unit:cd)

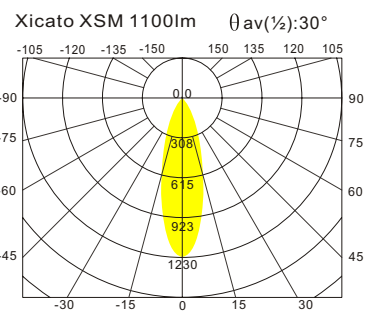

**XICATO**  
Light Engine

# LED Recessed Down light

- Adjustable



## Aberdeen



### LDW210

- Outer Trim : Alum. Die Cast
- Inner Trim : Alum. Die Cast
- Reflector : Angle 22°, 30°, 45°
- Diffuser : Clear Glass / Frosted Glass
- LED Power : Citizen 9W / 13W
- Version : Bridgelux Vero 10

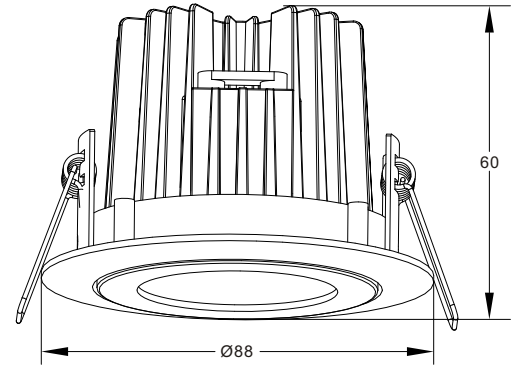

## Bird Nest - LED



### LD606

- Trim : Alum. Die Cast
- Gimbal : Alum. Die Cast
- Reflector : Angle 22°, 30°, 45°
- Housing : Steel Spinning
- Heat Sink : Alum. Extrusion
- LED Power : Citizen 13W
- Version : Bridgelux Vero 10

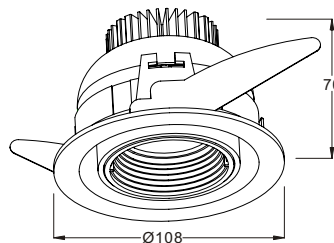

### Intensity(unit:cd)

Citizen 13W

$\theta_{av(1/2)}$ : 45°

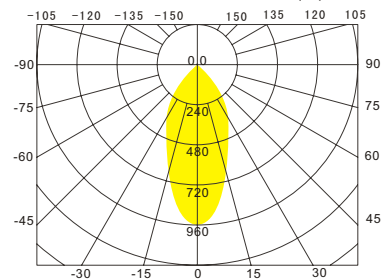

# LED Recessed Down light



## - Adjustable

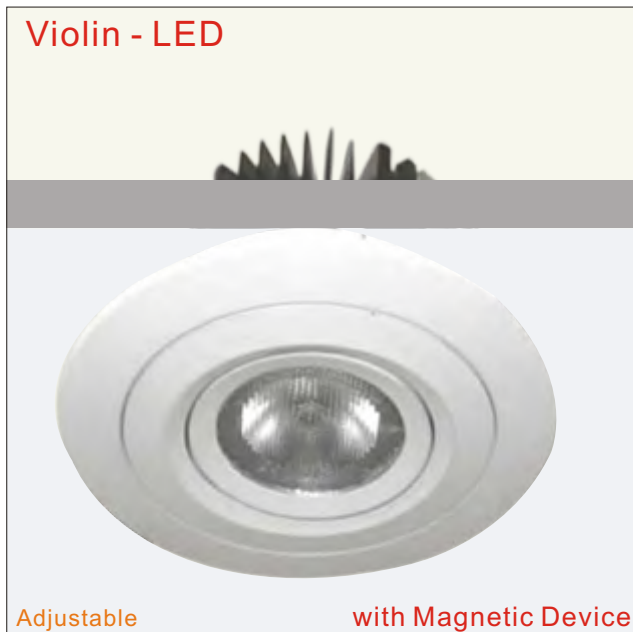

### LDW345 - LN

Outer Trim : Alum. Die Cast  
 Middle Trim : Steel Turning  
 Inner Trim : Steel Turning  
 Housing : Alum. Spinning  
 Lens : High Transmittance PMMA  
 Heat Sink : Alum. Extrusion  
 LED Power : Citizen 9W / 13W  
 Version : Bridgelux Vero 10

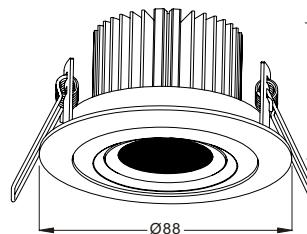
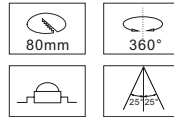

### Intensity(unit:cd)

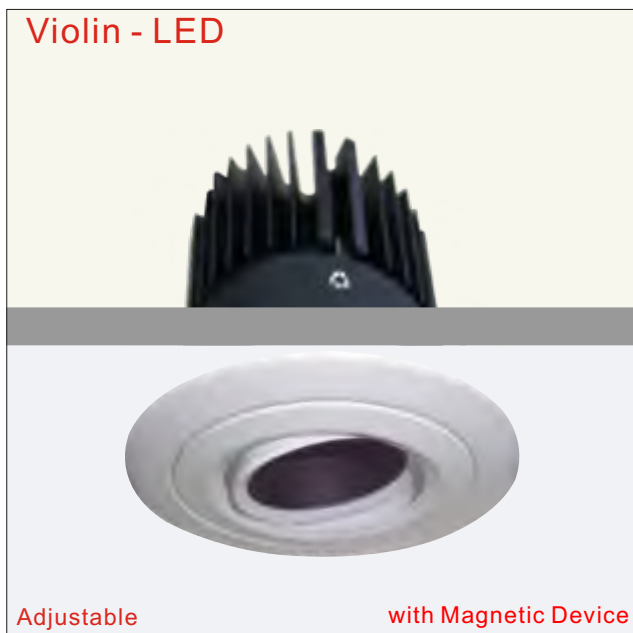
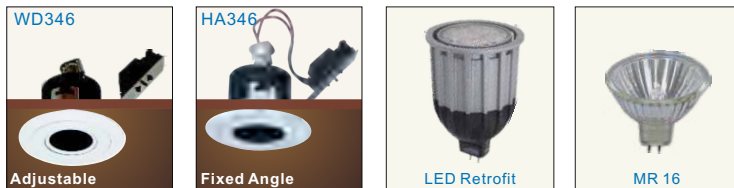
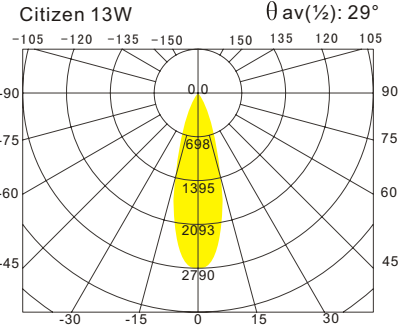

### LDW346 - AJ

Outer Trim : Alum. Die Cast  
 Inner Trim : Steel Turning  
 Reflector : Square Facet  
 Diffuser : Clear Tempered Glass  
 Heat Sink : Alum. Extrusion  
 LED Power : Citizen 9W / 13W  
 Version : Bridgelux Vero 10

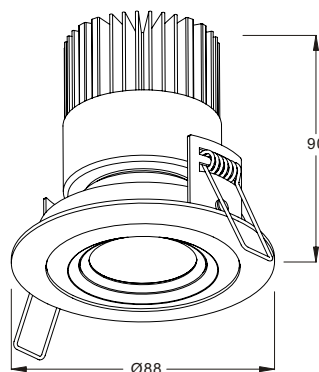
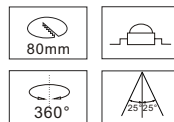

### Intensity(unit:cd)

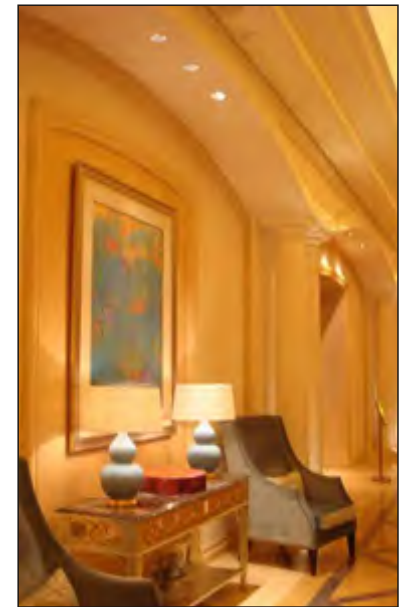
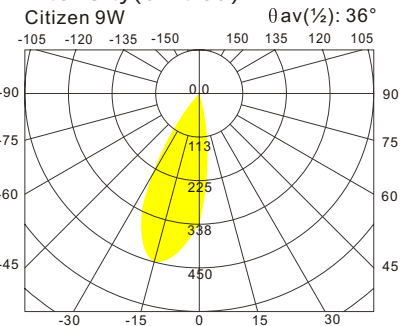

# LED Recessed Down light

## - Wings OD 108

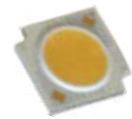

Citizen

Wings-AJ

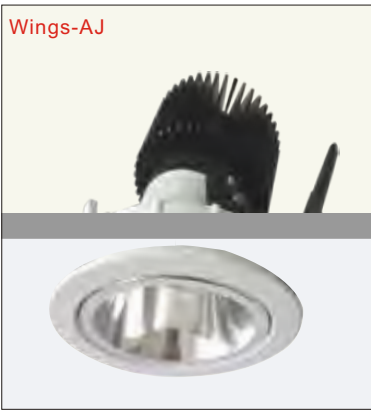

LDW2019A

Trim : Alum. Die Cast  
 Reflector : Clear Anodized  
 Heat Sink : Alum. Extrusion  
 LED Power : Citizen 13W

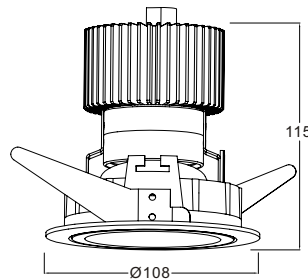
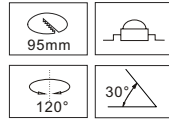

Intensity(unit:cd)

Citizen 13W

$\theta_{av}(\frac{1}{2})$ : 10°

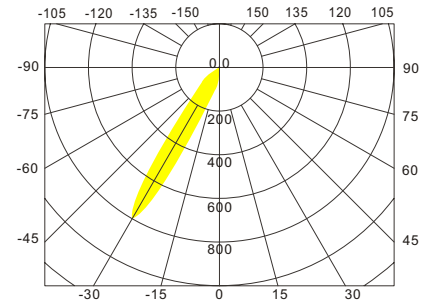

Wings-FX



LD602

Outer Trim : Alum. Die Cast  
 Reflector : High Pure Alum.  
 Clear Anodized  
 Heat Sink : Alum. Extrusion  
 LED Power : Citizen 13W

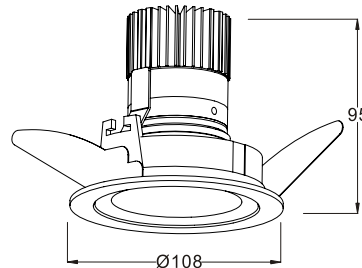

Intensity(unit:cd)

Citizen 13W

$\theta_{av}(\frac{1}{2})$ : 8°

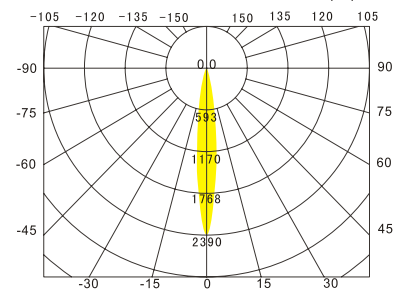

Wings-FX BK



LD605

Outer Trim : Alum. Die Cast  
 Inner Trim : Alum. Die Cast  
 Reflector : High Pure Alum.  
 Square Facet +  
 Black Paint  
 Heat Sink : Alum. Extrusion  
 LED Power : Citizen 13W

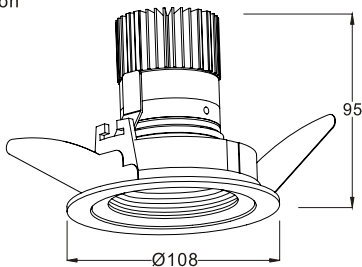
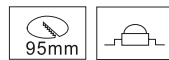

Intensity(unit:cd)

Citizen 13W

$\theta_{av}(\frac{1}{2})$ : 21°

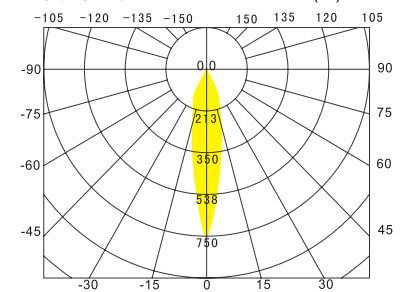

Wings-FX DG



LD607

Outer Trim : Alum. Die Cast  
 Inner Trim : Alum. Die Cast  
 Reflector : High Pure Alum.  
 Sand Blasting  
 Heat Sink : Alum. Extrusion  
 LED Power : Citizen 13W

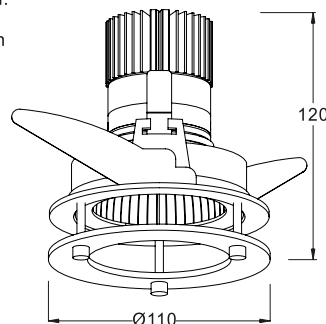

Intensity(unit:cd)

Citizen 13W

$\theta_{av}(\frac{1}{2})$ : 22°

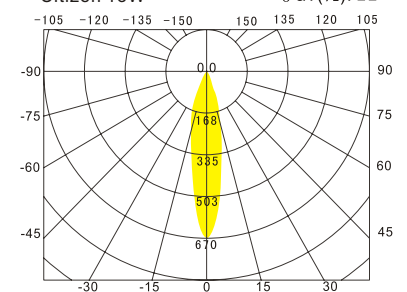

# LED Recessed Down light

## - Wall Washer



Citizen

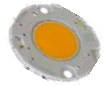

Bridgelux Vero

### Double Bass - LED



### LD2101

Trim : Alum. Die Cast  
 Low Reflector : High Pure Alum. Clear anodized  
 Upper Reflector : High Pure Alum. Square facet, Frosted & Anodized  
 Heat Sink : Alum. Extrusion  
 LED Power : Citizen 9W / 13W  
 Version : Bridgelux Vero 10

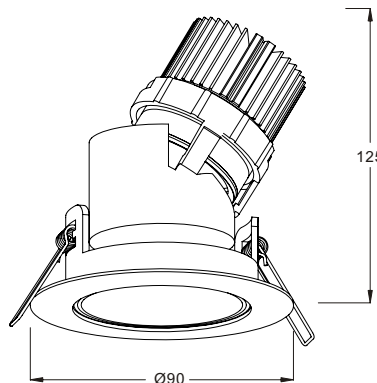

### Intensity(unit:cd)

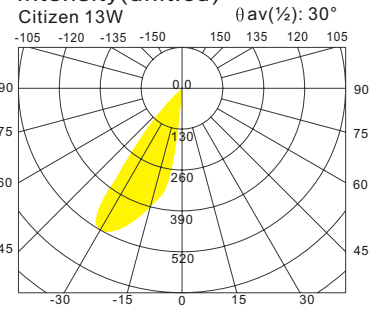

### HA2101



### Palm



### LD5979

Trim : Alum. Die Cast  
 Reflector : High Pure Alum. Stripe Facet, Clear Anodized  
 Diffuser : Semi Frosted Tempered Glass  
 Heat sink : Alum. Extrusion  
 LED Power : Citizen 13W / 18W / 28W  
 Versions : Bridgelux Vero 13 Fortimo SLM 2000lm PrevaLED Core Z3 2000lm

Remark:  
 Bracket can be extended.

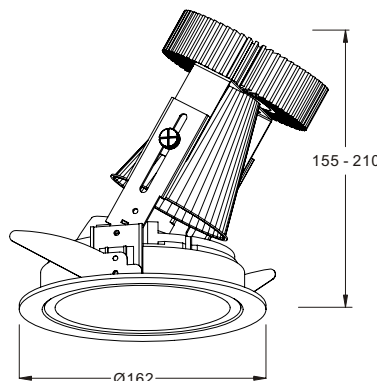
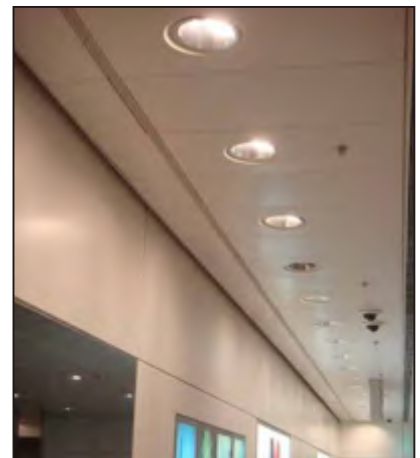
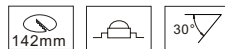

### Intensity(unit:cd)

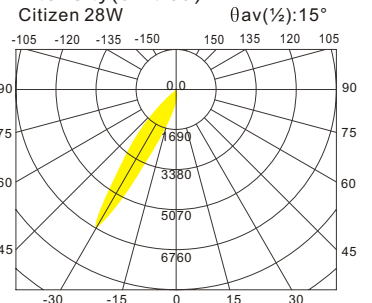

# LED Recessed Down light

## - Trimless



### LD401

Housing : Alum. Spinning  
 Reflector : High Pure Alum. Square Facet Frosted Anodized  
 Heat Sink : Alum. Extrusion  
 LED Power : Citizen 13W

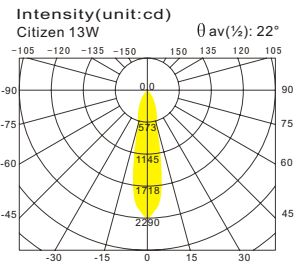
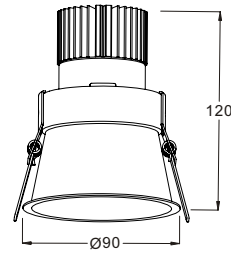

Suitable for 1028-CZ reflector

### LDW401

Housing : Alum. Spinning  
 Reflector : High Pure Alum. Square Facet Frosted Anodized  
 Heat Sink : Alum. Extrusion  
 LED Power : Citizen 13W

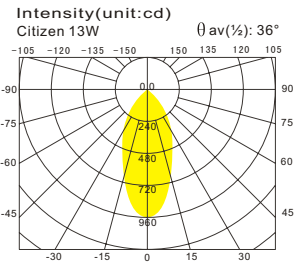
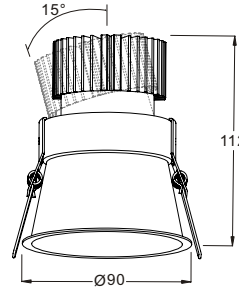

Suitable for 1021-CZ reflector



### LD6127-CZ

Housing : Alum. Spinning  
 Reflector : High Pure Alum. Sand Blasting  
 Heat Sink : Alum. Extrusion  
 LED Power : Citizen 28W  
 Versions : Bridgelux Vero 13  
 Fortimo SLM 2000lm  
 PrevaLED Core Z3 2000lm  
 Megaman TECOH RDx  
 Osram COINlight 111

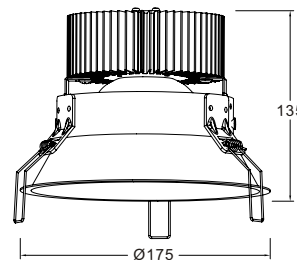

### Fixed Angle-COINlight

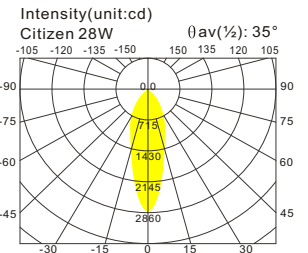
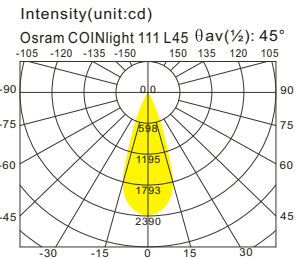

### LD8027-OC

Housing : Alum. Spinning  
 LED Power : Osram COINlight 111  
 Versions : Citizen 42W  
 Bridgelux Vero 18  
 Fortimo SLM 3000lm  
 PrevaLED Core Z3 3000lm  
 Megaman TECOH RDx

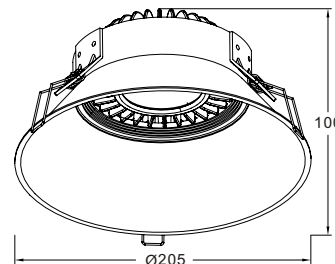
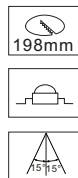

### Adjustable-COB

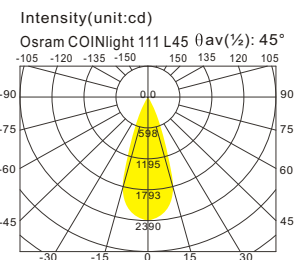
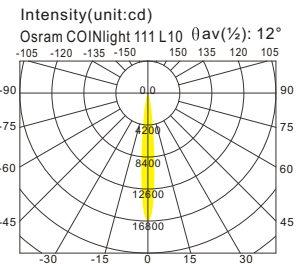



# LED Recessed Down light

- Adjustable



Citizen

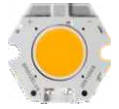

Bridgelux Vero 10



Prince

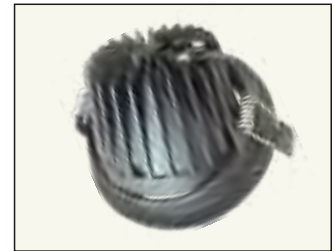

## Light distribution curves

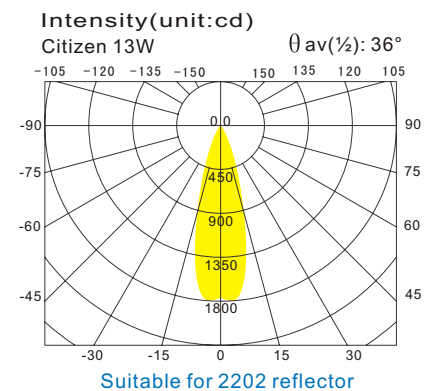
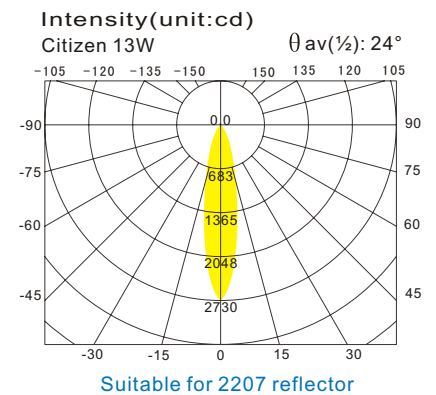
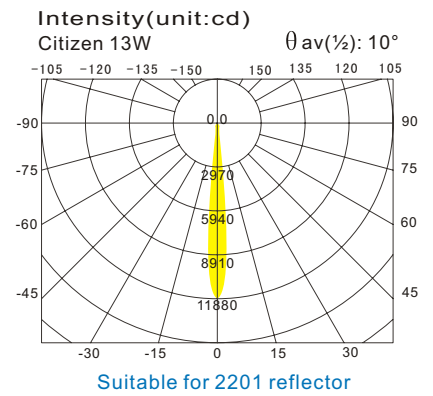

### LDW309

Housing : Alum. Die Cast  
Reflector : Angle 10°, 24°, 36°  
LED Power : Citizen 13W  
Version : Bridgelux Vero 10

Remark : Semi frosted or fully frosted glass could be optional

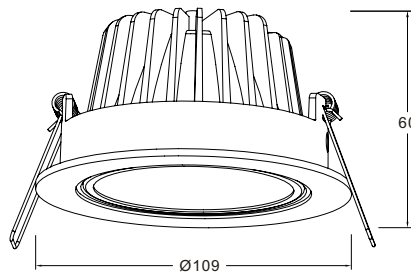
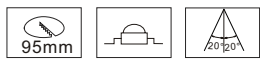

# LED Recessed Down light

- Adjustable

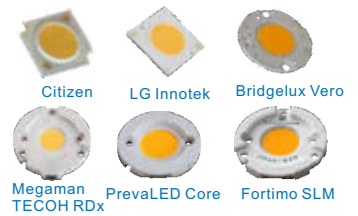

Olympiaded-LED



MH307-CDM-TM / JC

Trim : Alum. Die Cast  
Reflector: Pebble Facet  
Diffuser : Clear Tempered Glass  
Housing : Alum. Die Cast  
Socket : PGJ5 / GY6.35  
Lamp : CDM - TM 20W / JC Type

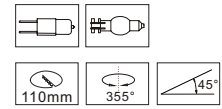

Size: Ø118 x 100mm



## LD307

Trim : Alum. Die Cast  
Housing : Alum. Die Cast  
Diffuser : Clear Tempered Glass  
Reflector : Angle 10°, 24°, 36°  
LED Power : Citizen 28W  
Versions : Bridgelux Vero 13  
          LG LEMW11 28W  
          Megaman TECOH RDX  
          Fortimo SLM 2000lm  
          PrevaLED Core Z3 2000lm (with active cooling)



(with active cooling)

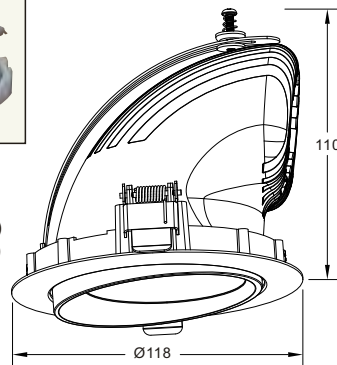

## Intensity(unit:cd)

Citizen 28W

$\theta_{av(1/2)}$ : 36°

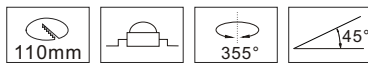
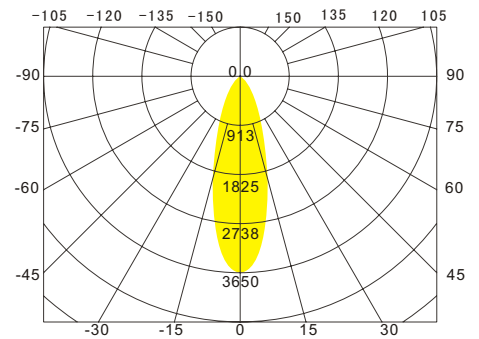

## Rhino-LED



## LD5142

Trim : Alum. Die Cast  
Housing : Alum. Die Cast  
Diffuser : Clear Tempered Glass  
Reflector : Pebble Facet  
LED Power : Citizen 42W(1050mA) 3000lm  
          Citizen 56W(1400mA) 4500lm(with active cooling)  
Versions : Fortimo SLM 46W 4500lm(with active cooling)  
          PrevaLED Core 42W 5000lm(with active cooling)  
          Tridonic SLE G2 50W 5950lm(with active cooling)

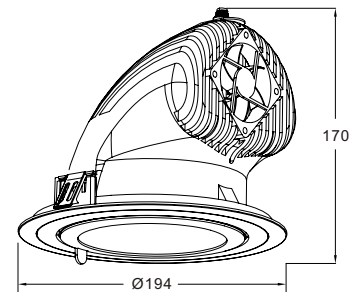
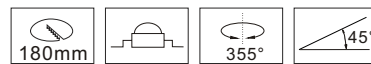

## Intensity(unit:cd)

Fortimo SLM 4500lm

$\theta_{av(1/2)}$ : 30°

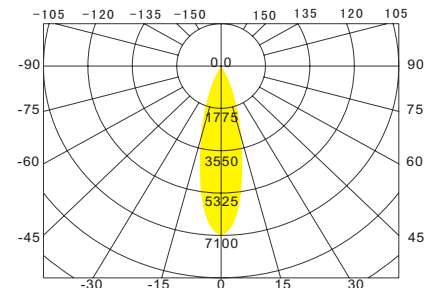

- ◆ Fin-shaped passive heat sink design
- ◆ Additional position for active cooling device
- ◆ 355° rotation
- ◆ 45° tilting angle

# LED Recessed Down light

- Adjustable

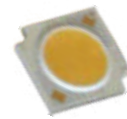

Citizen

Canary

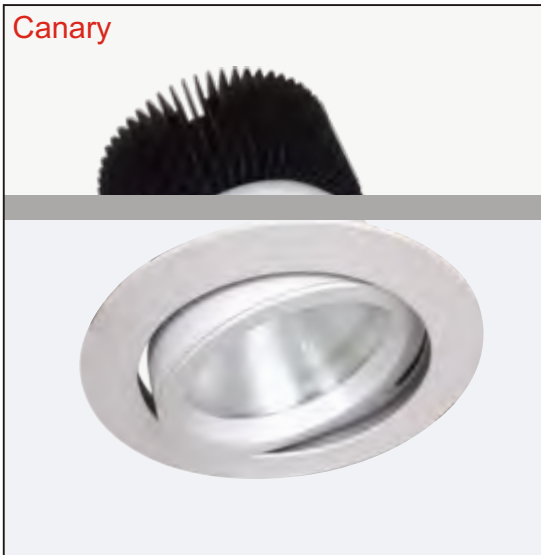

LD5906

Outer Trim : Alum. Die Cast  
 Inner Trim : Alum. Die Cast  
 Housing : Alum. Die Cast  
 Reflector : Sand Blasting  
 Diffuser : Clear Tempered Glass  
 Heat Sink : Alum. Extrusion  
 LED Power : Citizen 28W

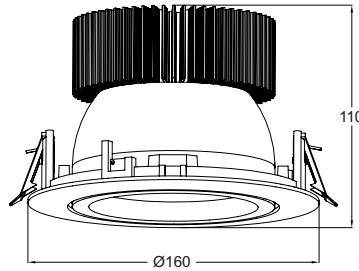
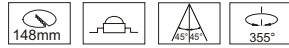

Intensity(unit:cd)

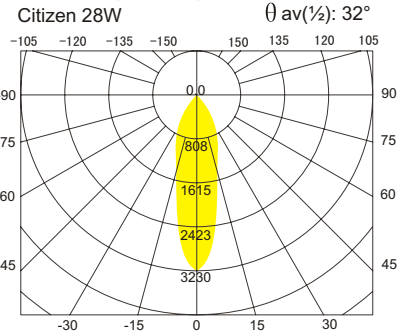

Toby - LED



LD432

Trim : Alum. Die Cast  
 Housing : Alum. Die Cast  
 Diffuser : Clear Tempered Glass  
 Reflector : Sand Blasting  
 Heat Sink : Alum. Extrusion  
 LED Power: Citizen 28W  
 Colour :  White  Gold  Silver

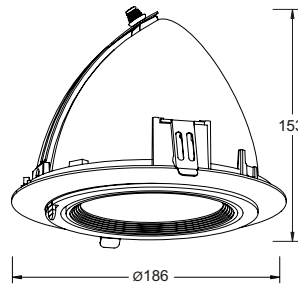

MH431

HQI 70W



LD433-OC

COIN Light 111



Intensity(unit:cd)

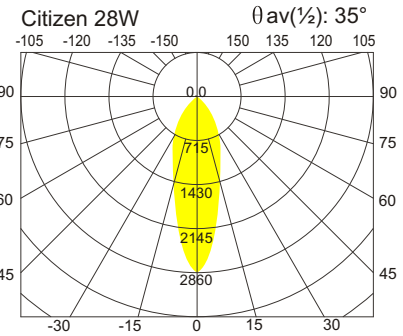

Lille



LD5108

Body : Alum. Die Cast  
 Diffuser : Clear Tempered Glass  
 Reflector : High Pure Alum.  
 Frosted & Anodized  
 Heat Sink : Alum. Extrusion  
 LED Power : Citizen 28W

Wall Wash Function

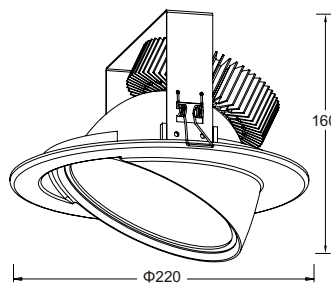

Intensity(unit:cd)

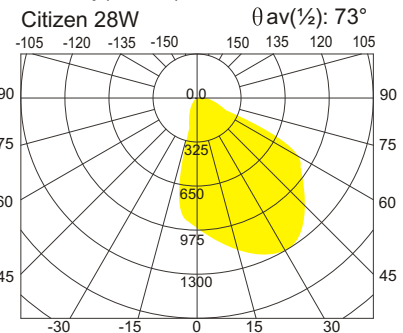

Fixing Angle:25°

# LED Recessed Down light

- Adjustable



Citizen



Bridgelux Vero

Calais - S



LD5905

- Outer Trim : Alum. Die Cast
- Inner Trim : Alum. Die Cast
- Housing : Alum. Die Cast
- Reflector : Sand Blasting
- Diffuser : Clear Tempered Glass
- Heat Sink : Alum. Extrusion
- LED Power : Citizen 28W
- Version : Bridgelux Vero 13

MH5905 (G8.5 Version)



Intensity(unit:cd)

Citizen 28W

$\theta_{av(1/2)}$ : 35°

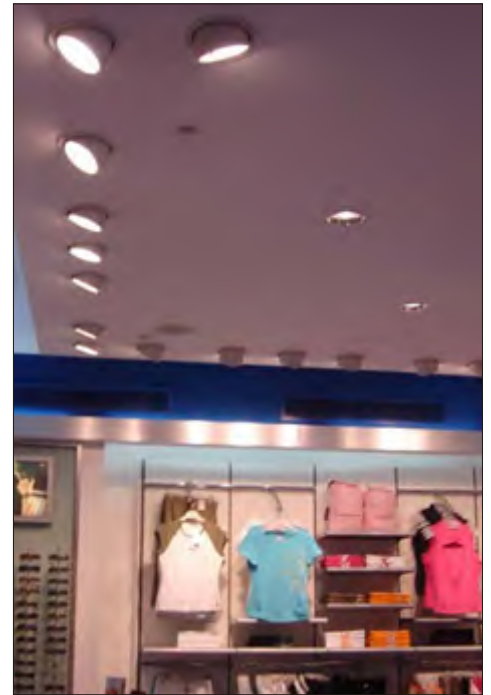
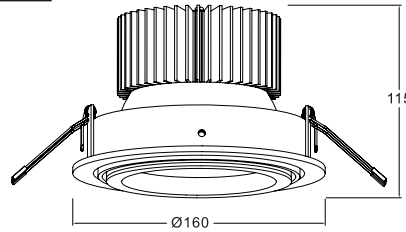
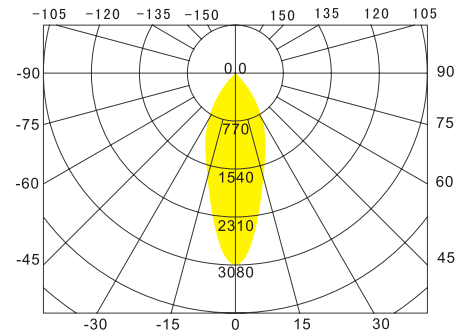

Calais - L



LD7905

- Outer Trim : Alum. Die Cast
- Inner Trim : Alum. Die Cast
- Housing : Alum. Die Cast
- Reflector : Stripe Facet , Sand Blasting
- Diffuser : Clear Tempered Glass
- Heat Sink : Alum. Extrusion
- LED Power : Citizen 42W
- Version : Bridgelux Vero 18

MH7905 (G12 Version)



Intensity(unit:cd)

Citizen 42W

$\theta_{av(1/2)}$ : 44°

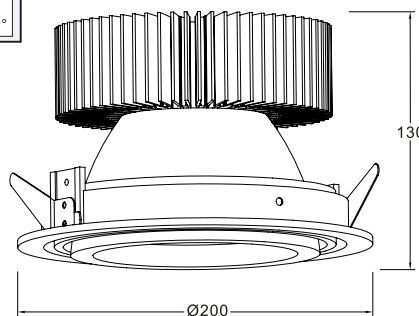
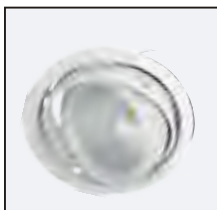
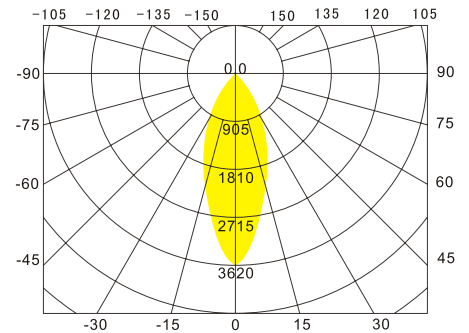

# LED Recessed Down light

## - Gimbal

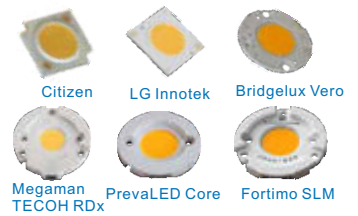

- LD5311**
- Outer Trim : Steel
  - Inner Trim : Alum. Die Cast
  - Reflector : Pebble Facet
  - Bracket : Steel
  - Diffuser : Clear Tempered Glass
  - Heat Sink : Alum. Extrusion
  - LED Power : Citizen 28W
  - Versions : Bridgelux Vero 13, Fortimo SLM 2000lm, PrevaLED Core Z3 2000lm, LG LEMWM11 28W, Megaman TECOH RDx



### Light distribution curves

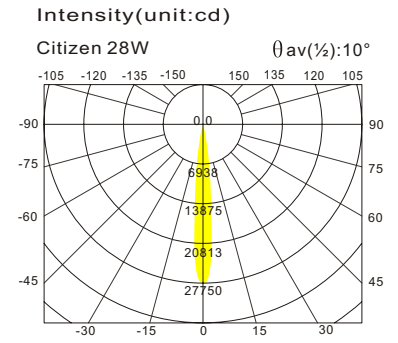

### Suitable for 4201 reflector

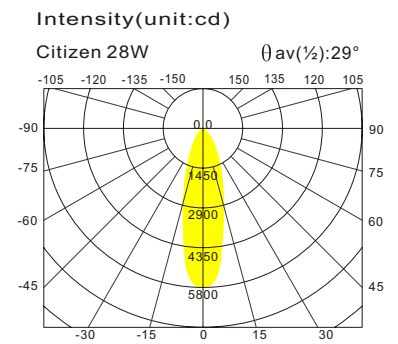

### Suitable for 4301 reflector

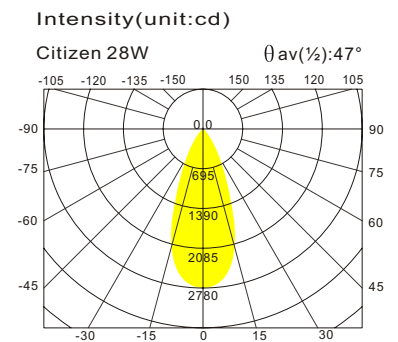

### Suitable for 4401 reflector

IES file provided upon request



- LD5411**
- Trim : Alum. Die Cast
  - Reflector : Pebble Facet
  - Bracket : Steel
  - Diffuser : Clear Tempered Glass
  - Heat Sink : Alum. Extrusion
  - LED Power : Citizen 28W
  - Versions : Bridgelux Vero 13, Fortimo SLM 2000lm, PrevaLED Core Z3 2000lm, LG LEMWM11 28W, Megaman TECOH RDx

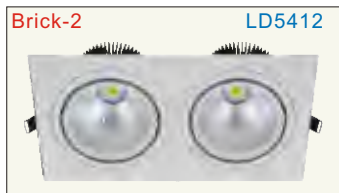
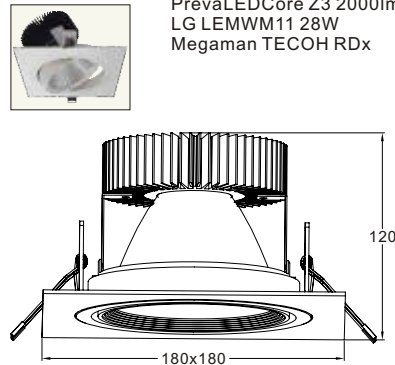

### Universal Reflector

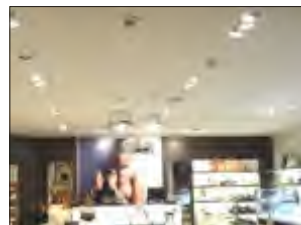

For more information , Please contact our sales department.

# LED Recessed Down light

## - Panel



Fortimo SLM



Xicato XSM



Jet-R

### LD5611-R

- Outer Trim : Steel
- Inner Trim : Alum. CNC Turning
- Reflector : Pebble Facet
- Heat Sink : Alum. Extrusion
- LED Power : Fortimo SLM 2000lm / 3000lm / 4500lm
- Version : Xicato XSM 2000lm / 3000lm

Remable :  
3000lm or higher power, active cooling device is required

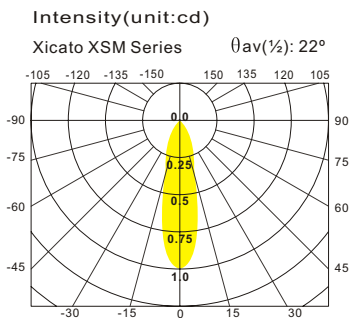
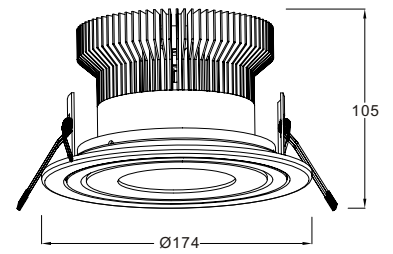

3206T-XC

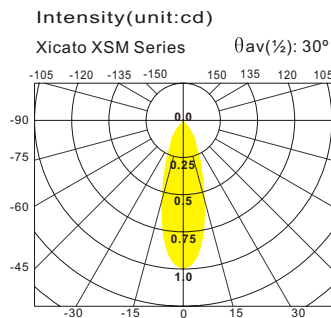

3204T-XC

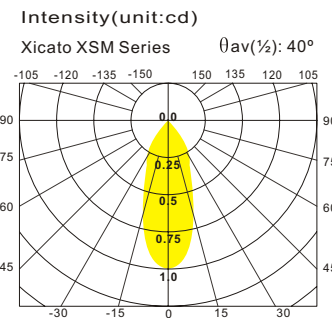

3205T-XC

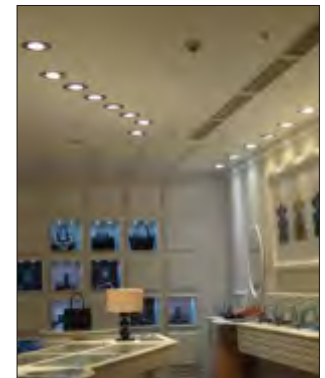

Jet-S

### LD5611-S

- Outer Trim : Alum. Pressing
- Inner Trim : Alum. CNC Turning
- Reflector : Pebble Facet
- Heat Sink : Alum. Extrusion
- LED Power : Fortimo SLM 2000lm / 3000lm / 4500lm
- Version : Xicato XSM 2000lm / 3000lm

Remable :  
3000lm or higher power, active cooling device is required

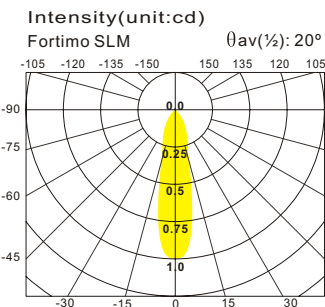
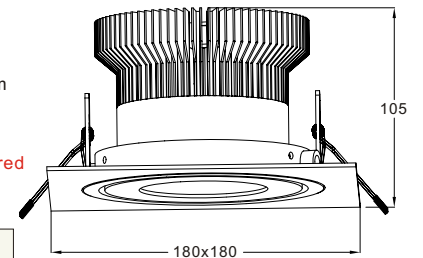

3206-FM

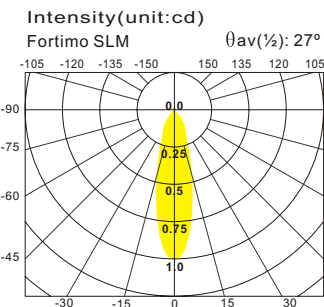

3204-FM

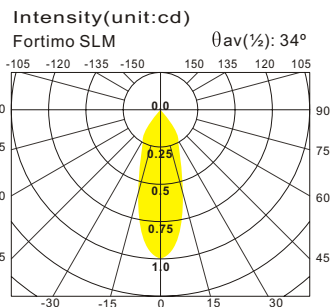

3205-FM

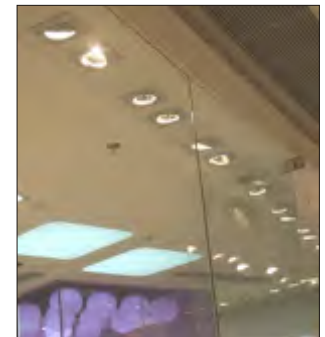

# LED Recessed Down light

## - Kardo Mini

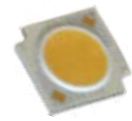

Citizen

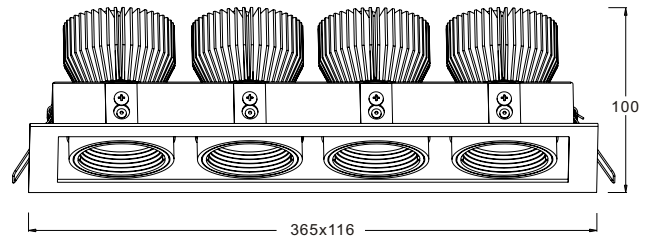
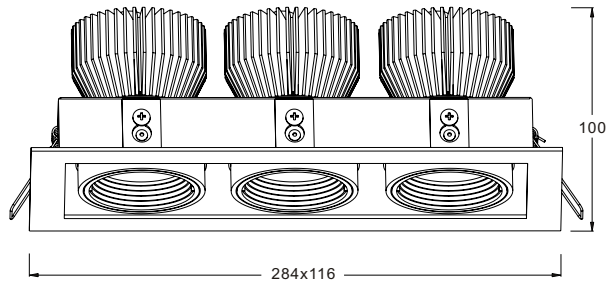
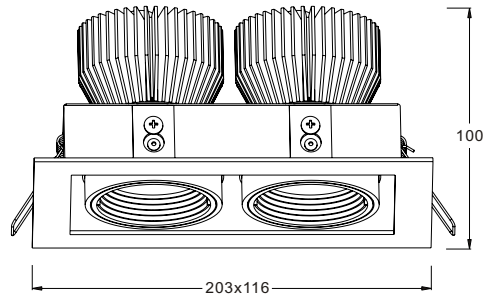
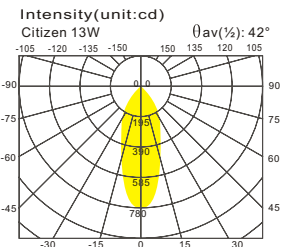
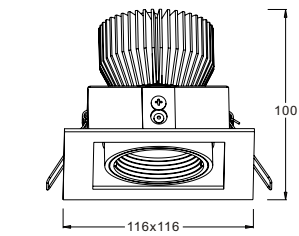

- Trim : Steel Sheet
- Gimbal : Alum. Die Cast
- Housing : Steel Sheet
- Heat Sink : Alum. Extrusion
- LED Power : Citizen 13W / 18W
- Colour : ■BK, ■GY, □WH



# LED Recessed Down light

## - Kardo Classic

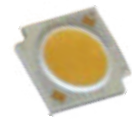

Citizen

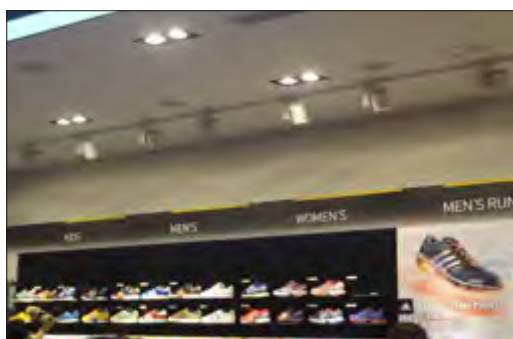
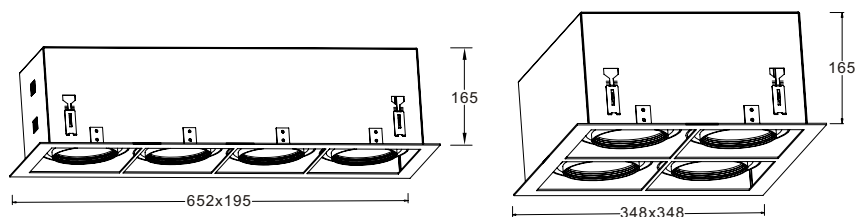
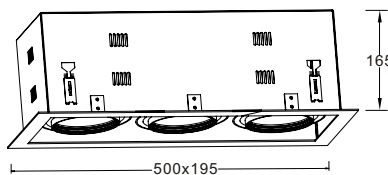
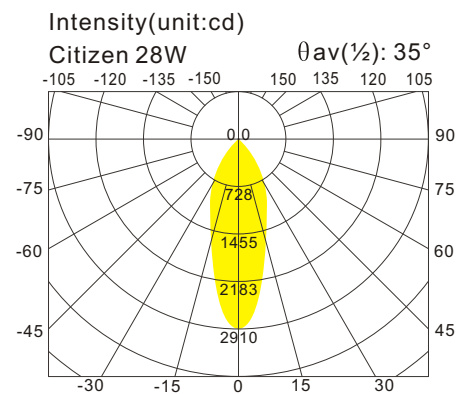
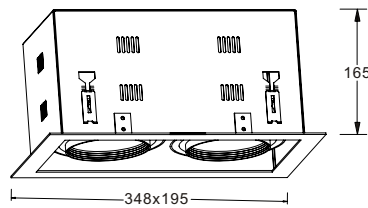
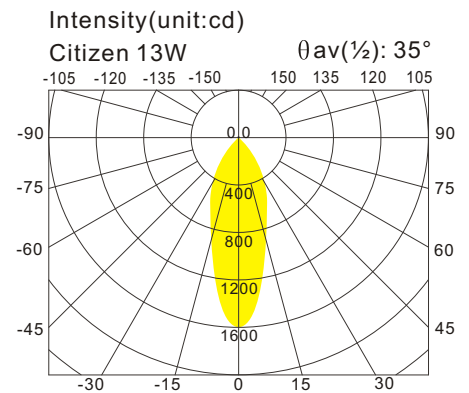
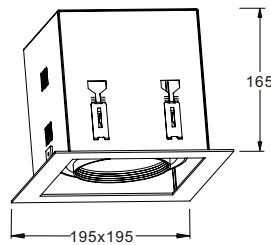

- Trim : Steel Sheet
- Gimbal : Alum. Die Cast
- Housing : Steel Sheet
- Diffuser : Clear Tempered Glass
- LED Power : Citizen 13W / 28W

Adjustable Angle: Both Rings Tilt angle 25 degree.

Except the two type LED source heads, you can select other conventional source heads, such as : AR111, CDM-T, CDM-R, CDM-R111 and PAR30.

©Copyright is reserved by Widegerm Lighting Ltd..  
Widegerm reserves the right to change data and specification without notice



# LED Recessed Down light

## - Xicato Series



Metz-XLM

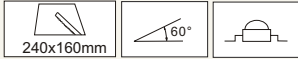

LD0701-XC

- Trim : Alum. Die Cast
- Body : Alum. Die Cast
- Reflector : Matt Finish
- Diffuser : Clear Tempered Glass
- Heat Sink : Alum. Extrusion
- LED Power : Xicato XLM 2200lm / 3000lm

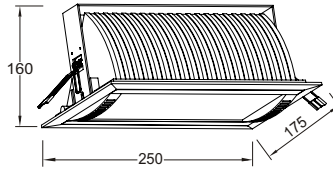

Application :  
Retail and Sign Board lighting,  
gallery

6274-XC



6275-XC



Intensity(unit:cd)

XLM 2200lm  $\theta_{av}(1/2):56^\circ$

$\theta_{90^\circ}(1/2):104^\circ$

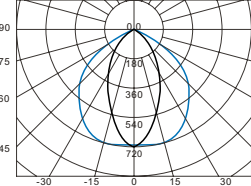

6274-XC

Intensity(unit:cd)

XLM 2200lm  $\theta_{av}(1/2):104^\circ$

$\theta_{90^\circ}(1/2):106^\circ$

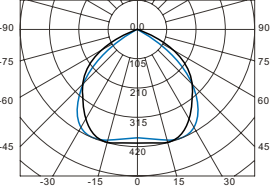

6275-XC

Quarter-XLM



Wall Washing

LD8221

- Trim : Alum. Die Cast
- Body : Alum. Die Cast
- Reflector : Asymmetric matt
- Diffuser : Clear Tempered Glass
- Heat Sink : Alum. Extrusion
- LED Power : Xicato XLM 2200lm / 3000lm

Application :  
Retail, Walkway and  
Terminal Building

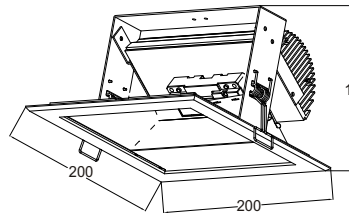
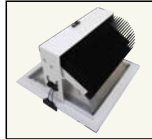

Intensity(unit:cd)

Xicato XLM 2200lm  $\theta_{av}(1/2):56^\circ$

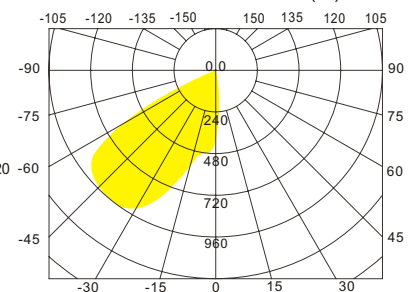

Hexagona



LD6111

- Trim : Alum. Die Cast
- Reflector : matt
- Diffuser : Clear Tempered Glass
- Heat sink : Alum. Extrusion
- LED Power : Xicato XLM 3000lm / 4000lm

Application :  
Bank, restaurant, hotel, office,  
apartment lobby, hospital,  
shopping mall, corridor &  
public interior area

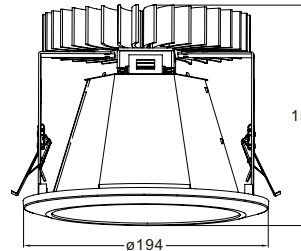

Intensity(unit:cd)

Xicato XLM 3000lm  $\theta_{av}(1/2):66^\circ$

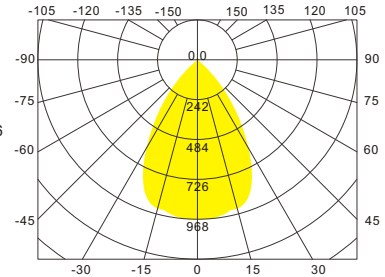

Champagne



LD6119

- Trim : Alum Die Cast
- Reflector : Pure Alum. , Sand Blasting
- Heat Sink : Alum. Extrusion
- Bracket : Steel
- LED Power : Xicato XSM 2000lm / 3000lm

Application :  
Bank, restaurant, hotel, office,  
apartment lobby, hospital,  
shopping mall, corridor &  
public interior area

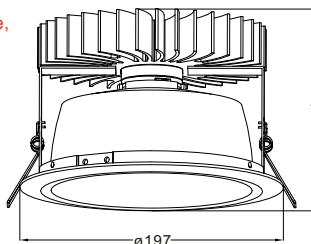

Intensity(unit:cd)

Xicato XSM 2000lm  $\theta_{av}(1/2):91^\circ$

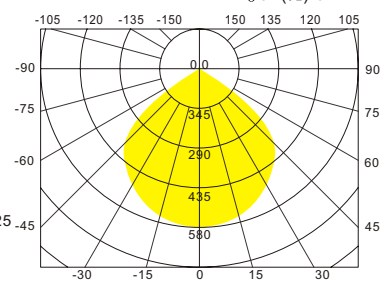

**XICATO**

Light Engine

# LED Recessed Down light



Citizen



PrevaLED Core

## - Canton

### Canton



### LD6068

Housing : Alum. Die Cast  
 Reflector : High Pure Alum. Clear / Frost Anodized  
 Diffuser : Tempered Glass  
 LED Power : Citizen 28W

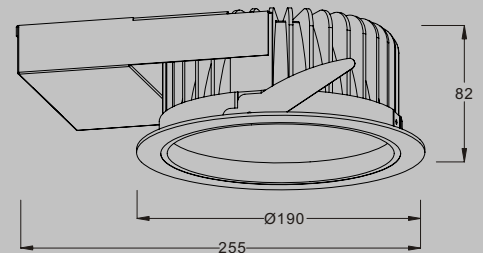

Canton, a recessed LED downlight is composed of Aluminium Casting housing and heat sink device. The intelligent design of structure allows the installation of different type of LED arrays. In addition, vary lens is provided to adjust to the light output and beam angle. Canton has the most common size of cut-hole (165mm), it is easy to replace the traditional compact fluorescent downlights without changing to the ceiling.



#### LD6068 - Citizen 28W

Intensity(unit:cd)  $\theta_{av}(\frac{1}{2})$ : 86°

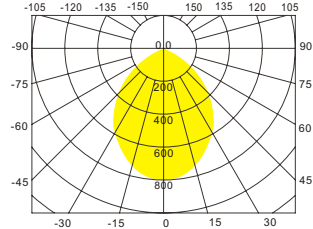

Frost Tempered Glass



#### LD6068 - Citizen 28W

Intensity(unit:cd)  $\theta_{av}(\frac{1}{2})$ : 89°

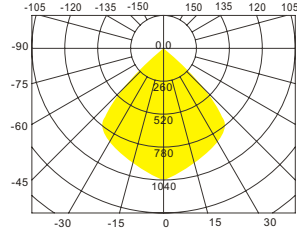

Clear Tempered Glass

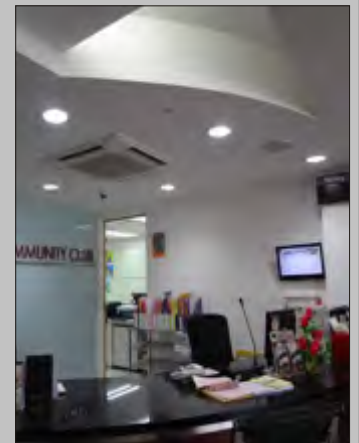

### LD6078-OR

Housing : Alum. Die Cast  
 Reflector : Frost and Stripe Facet  
 Diffuser : Clear Tempered Glass  
 Icy Texture Lens (Medium Beam)  
 Driver Box : Steel  
 LED Power : PrevaLED Core Z3 2000lm

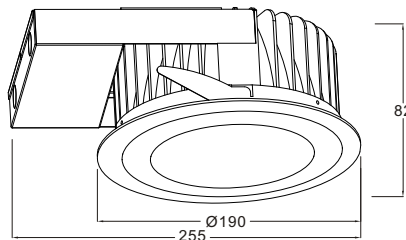

#### Intensity(unit:cd)

PrevaLED Core Z3 2000lm  $\theta_{av}(\frac{1}{2})$ : 45°

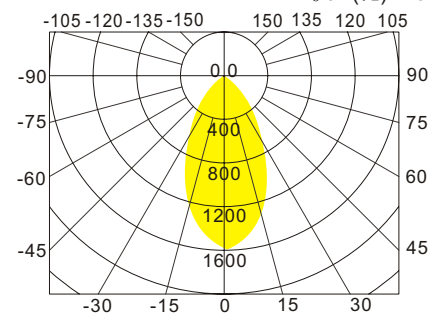

# LED Recessed Down light

- Wien



Citizen

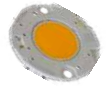

Bridgelux Vero



## LD3018

Trim : Alum. Die Cast  
 Reflector : High Pure Alum.  
 Stripe Facet, Clear Anodized  
 Diffuser : Semi Frosted Tempered  
 Glass / Satin Ice Acrylic  
 Heat sink : Alum. Extrusion  
 LED Power : Citizen 13W  
 Version : Bridgelux Vero 10

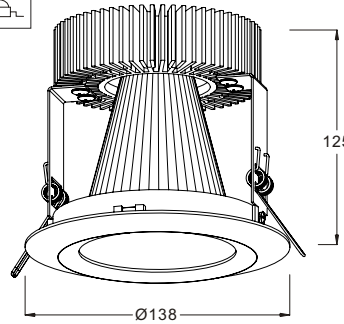

Intensity(unit:cd)

Citizen 13W

$\theta_{av}(\frac{1}{2})$ : 33°

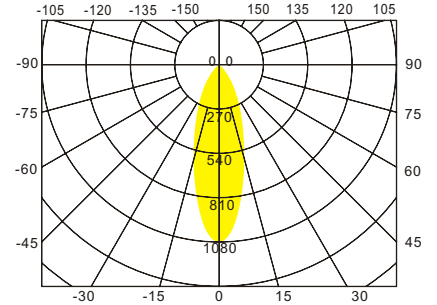

## LD4018

Trim : Alum. Die Cast  
 Reflector : High Pure Alum.  
 Stripe Facet,  
 Clear Anodized  
 Diffuser : Semi Frosted Tempered  
 Glass / Satin Ice Acrylic  
 Lens upon Request  
 Heat sink : Alum. Extrusion  
 LED Power : Citizen 18W  
 Version : Bridgelux Vero 10

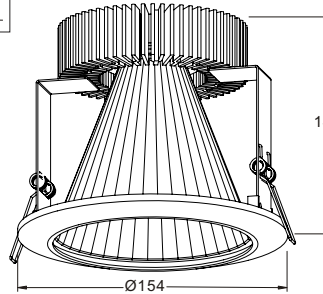
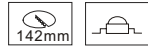

Intensity(unit:cd)

Citizen 18W

$\theta_{av}(\frac{1}{2})$ : 36°

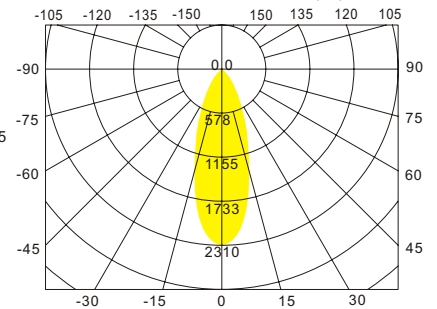

## LD6028

Trim : Alum. Die Cast  
 Reflector : High Pure Alum.  
 Stripe Facet,  
 Clear Anodized  
 Diffuser : Semi Frosted Tempered  
 Glass / Satin Ice Acrylic  
 Lens upon Request  
 Heat sink : Alum. Extrusion  
 LED Power : Citizen 28W  
 Version : Bridgelux Vero 13

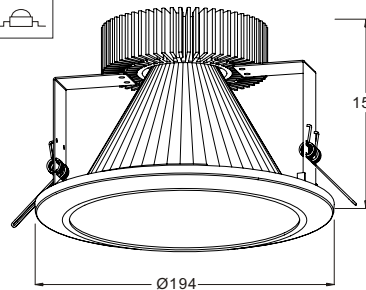

Intensity(unit:cd)

Citizen 28W

$\theta_{av}(\frac{1}{2})$ : 46°

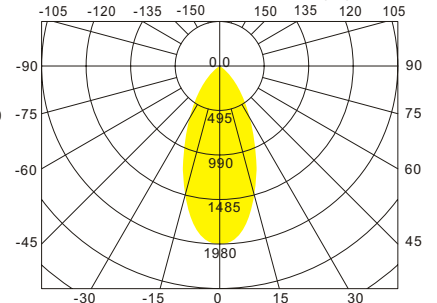

# LED Recessed Down light

## - PrevaLED by Osram



Deco - LED

### LD4019-Cube

Trim : Alum. Die Cast  
 Reflector : Stripe Facet, Sand Blasting  
 LED Power : PrevaLED Cube AC 1100lm  
 PrevaLED Cube AC 2000lm

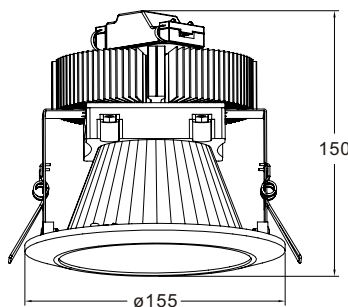

PrevaLED® Cube AC



### Benefits of the light source

- Power on-board through integrated driver electronics
- Flicker free
- Low height of the Optical Contact Area (OCA) of 18.6mm for compact luminaire designs
- Robust design for easy thermal management and long lifetime

### Applications

For general illumination in:

- Hospitality: Hotels, Restaurants
- Public, Commercial & Office buildings
- Corridors
- Shops
- Secondary rooms: garages, storage,...

### Technical features

- Luminous flux: typ. 1100lm / 2000lm
- Light colors:
  - Warm white (3000K)
  - Cool white (4000K)

### Technical operating data

Product	Color	nominal flux (lm)	nominal If (mA)	nominal Power(W)	min. nominal flux [lm]	max. nominal flux [lm]	Color Temp. (K)	Efficacy (lm/W)
PL-CUBE-1100-830-0.35A-G1	Warm white	1100	331	11.1	990	1320	3000	99
PL-CUBE-1100-840-0.35A-G1	Cool white	1100	304	10.1	990	1320	4000	109
PL-CUBE-2000-830-0.5A-G1	Warm white	2000	531	21.2	1800	2400	3000	95
PL-CUBE-2000-840-0.5A-G1	Cool white	2000	486	19.2	1800	2400	4000	104

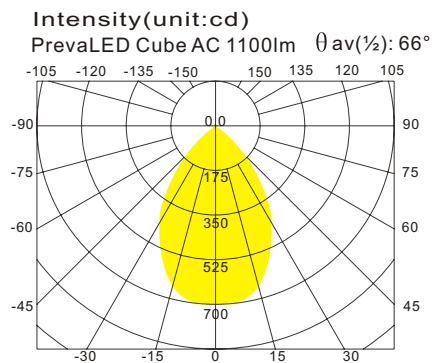

Deco - LED

### LD4019-OC

Trim : Alum. Die Cast  
 Reflector : Stripe Facet, Sand Blasting  
 Diffuser : Clear Tempered Glass / Frosted Tempered Glass  
 LED Power : Osram CT 12A L45°  
 Wattage : 22.5W 1880lm

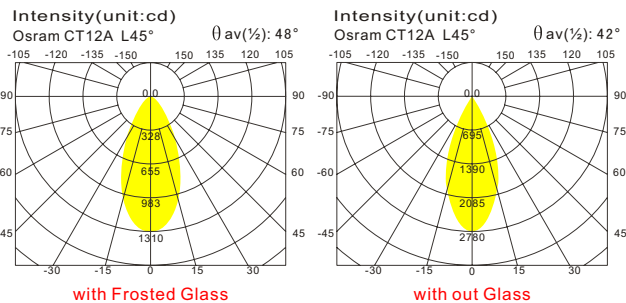
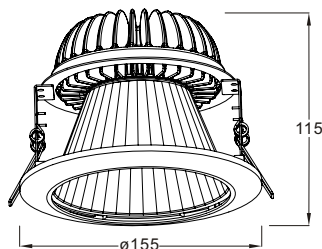

# LED Recessed Down light

## - PrevaLED by Osram

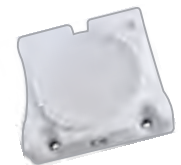

PrevaLED® Cube AC



Deco - LED

### LD6115

- Outer Trim : Alum. Die Cast
- Reflector : High Purity Alum. Sand Blasting
- Diffuser : Clear Tempered Glass / without Glass
- Heat Sink : Alum. Extrusion
- Bracket : Steel
- LED Power : PrevaLED Cube AC 1100lm  
PrevaLED Cube AC 2000lm

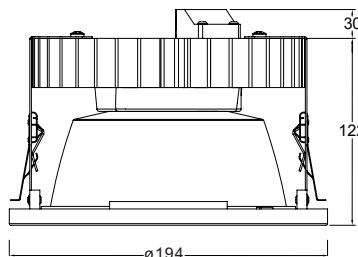

LD6115-CC

LD6115(IP65)

### Intensity(unit:cd)

PrevaLED Cube AC 1100lm  $\theta_{av}(\frac{1}{2}):102^\circ$

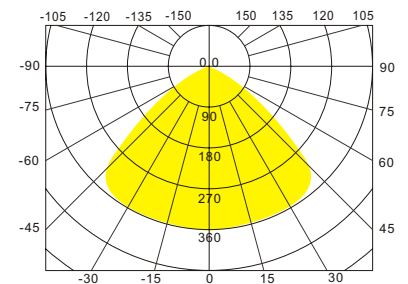

Deco - LED

LD8115-CC

### LD8115

- Outer Trim : Alum. Die Cast
- Reflector : High Purity Alum. Sand Blasting
- Diffuser : Clear Tempered Glass / without Glass
- Heat Sink : Alum. Extrusion
- Bracket : Steel
- LED Power : PrevaLED Cube AC 2000lm



LD8115(IP65)

### Intensity(unit:cd)

PrevaLED Cube AC 2000lm  $\theta_{av}(\frac{1}{2}):100^\circ$

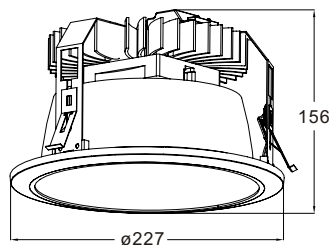
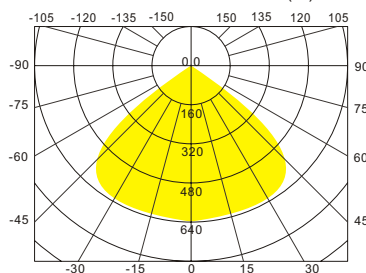

### Benefits of the light source

- Power on-board through integrated driver electronics
- Flicker free
- Low height of the Optical Contact Area (OCA) of 18.6mm for compact luminaire designs
- Robust design for easy thermal management and long lifetime

### Applications

For general illumination in:

- Hospitality: Hotels, Restaurants
- Public, Commercial & Office buildings
- Corridors
- Shops
- Secondary rooms: garages, storage,...

### Technical features

- Luminous flux: typ. 1100lm/ 2000lm / 3000lm
- Light colors:
  - Warm white (3000K)
  - Cool white (4000K)



## Accessories



### Technical operating data

Product	Color	nominal flux (lm)	nominal If (mA)	nominal Power (W)	min. nominal flux (lm)	max. nominal flux (lm)	Color Temp. (K)	Efficacy (lm/W)
PL-CUBE-1100-830-0.35A-G1	Warm white	1100	331	11.2	990	1320	3000	99
PL-CUBE-1100-840-0.35A-G1	Cool white	1100	304	10.1	990	1320	4000	109
PL-CUBE-2000-830-0.5A-G1	Warm white	2000	531	21.2	1800	2400	3000	95
PL-CUBE-2000-840-0.5A-G1	Cool white	2000	486	19.2	1800	2400	4000	104
PL-CUBE-3000-830-0.7A-G1	Warm white	3000	745	32.4	2700	3600	3000	93
PL-CUBE-3000-840-0.7A-G1	Cool white	3000	682	29.4	2700	3600	4000	102

# LED Recessed Down light

## - Disk



Philips Disk 800lm



LD 2037

- 14W 800lm Philips Disk
- Low Cost, Low Energy Consumption
- Low Maintenance Cost
- Easy installation

Driver inside with in the module, no external gear required

### Application:

- Replacement for MR16 Fixture
- Retail, Hotel, Public area and Home

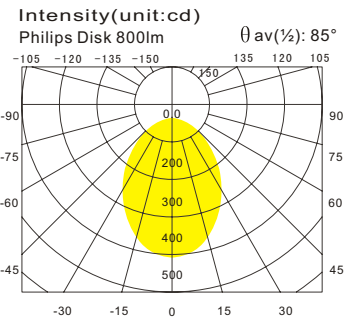
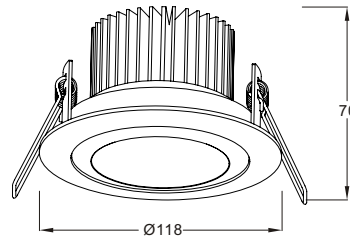

LD 2038

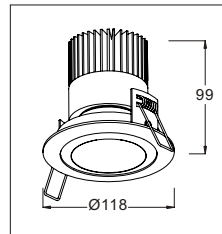

### Colour Temperature:

- 2700k warm white
- 5000k cool white

### Product specification

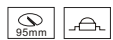
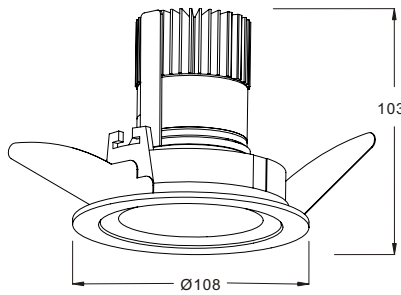

Type	Lightn output (lm)	Module power (W)	CCT (K)	CRI (R)	Life time @max (hrs)	T <sub>a</sub> max [°C]
fortimo LED disk module 800/840	850	15.2W	4000	80	25000	70°
fortimo LED disk module 800/927	820	14.5W	2700	90	25000	70°
fortimo LED disk module 300/827	300	7.7W	2700	80	25000	65°

For more information upon your require.



LD 2601

# LED Recessed Down light

## - Disk and Twistable



### Philips Fortimo Disk



#### LD4038

- Trim : Alum. Die Cast
- Reflector : High Pure Alum.  
Stripe Facet,  
Clear Anodized
- Diffuser : Clear Tempered Glass
- Heat sink : Alum. Extrusion
- LED Power : Philips Disk 800lm

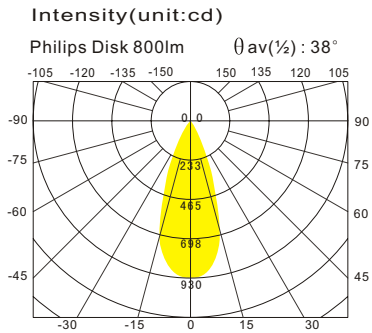
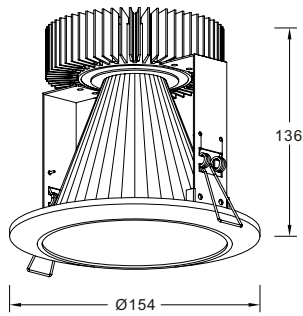
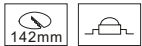

### Philips Fortimo Twistable

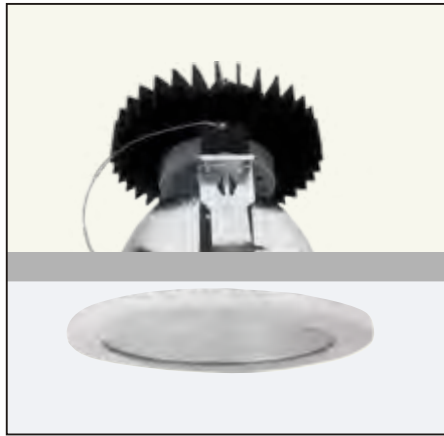

#### LD6120

- Trim : Alum. Die Cast
- Reflector : High Pure Alum.  
Sand Blasting
- Diffuser : Clear Tempered Glass
- Heat sink : Alum. Extrusion
- LED Power : Fortimo Twistable 1100lm
- Version : Megaman TECOH CFX

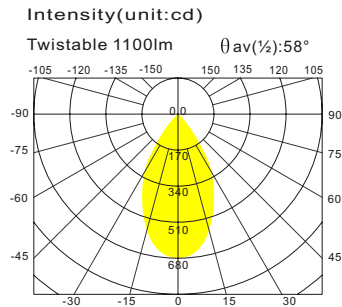
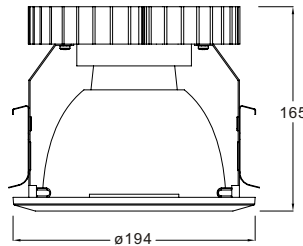
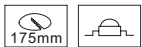

#### LD8120

- Trim : Alum. Die Cast
- Reflector : High Pure Alum.  
Sand Blasting
- Diffuser : Clear Tempered Glass
- Heat sink : Alum. Extrusion
- LED Power : Fortimo Twistable 2000lm
- Version : Megaman TECOH CFX

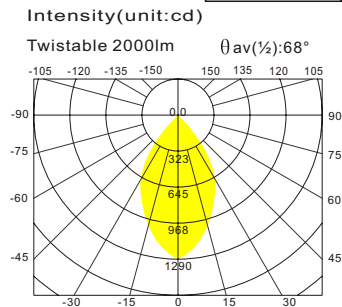
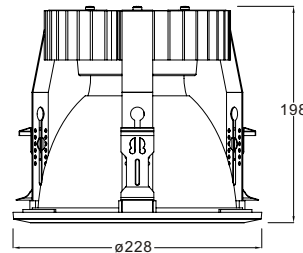
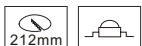

# LED Recessed Down light

## - Deco with Fortimo



### LD2001

Trim : Alum. Die Cast  
Reflector : Stripe Facet , Etch  
Diffuser : Clear Tempered Glass  
Heat Sink : Alum. Extrusion  
LED Power : Fortimo SLM 2000lm  
Version : PrevaLED Core DC / AC 2000lm

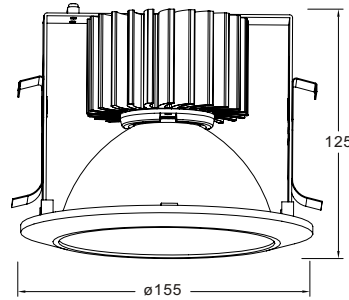
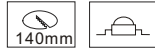

### Intensity(unit:cd)

Fortimo SLM 2000lm

$\theta_{av}(\frac{1}{2})$ : 42°

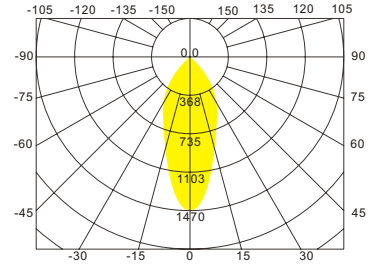

### LD6110

Trim : Alum. Die Cast  
Reflector : High Pure Alum.  
Sand Blasting  
Diffuser : Clear Tempered Glass  
Bracket : Steel  
Heat Sink : Alum. Extrusion  
LED Power : Fortimo DLM 1100lm / 2000lm  
Version : PrevaLED Cube AC 2000lm

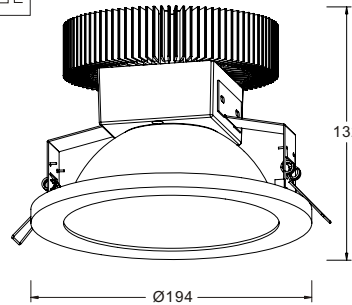
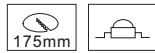

### Intensity(unit:cd)

Fortimo DLM 1100lm

$\theta_{av}(\frac{1}{2})$ : 65°

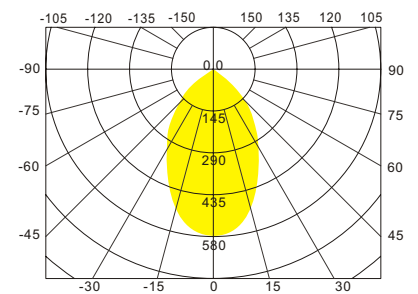

### LD5817

Trim : Alum. Die Cast  
Reflector : High Pure Alum., Clear  
Heat sink : Alum. Extrusion  
LED Power : Fortimo DLM 1100lm / 2000lm  
Version : PrevaLED Cube AC 2000lm

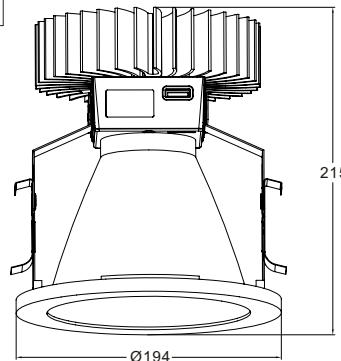

### Intensity(unit:cd)

Fortimo DLM 1100lm

$\theta_{av}(\frac{1}{2})$ : 36°

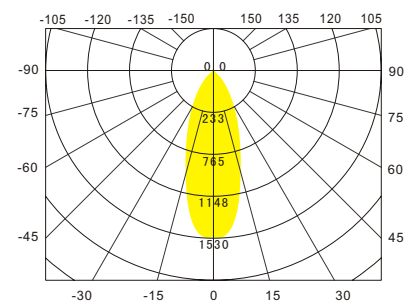



# LED Recessed Down light

## - Deco with Fortimo



Fortimo DLM-Int



Fortimo DLM



PrevaLED Cube AC

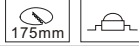

### LD6121

- Trim : Alum. Die Cast
- Reflector : High Purity Alum.  
Diamond Facet
- Diffuser : Clear Tempered Glass
- Heat sink : Alum. Extrusion
- LED Power : Fortimo DLM (DC) 1100lm  
Fortimo DLM (DC) 2000lm
- Versions : Fortimo DLM-Int (AC) 1100lm  
Fortimo DLM-Int (AC) 2000lm  
PrevaLED Cube (AC) 1100lm  
PrevaLED Cube (AC) 2000lm

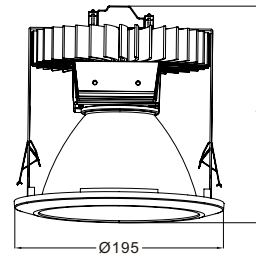
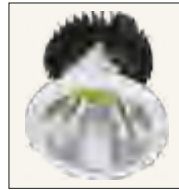

### Intensity(unit:cd)

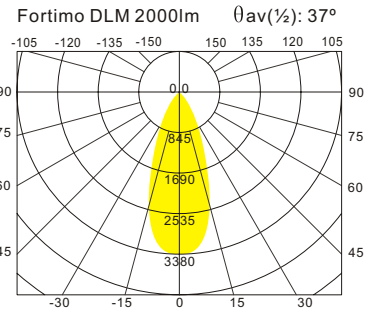

### LD10028

- Trim : Alum. Die Cast
- Housing : Polycarbonate
- Reflector : High Purity Alum.  
Sand Blasting
- Diffuser : Clear Tempered Glass
- Heat Sink : Alum. Extrusion
- LED Power : Fortimo DLM (DC) 2000lm  
Fortimo DLM (DC) 3000lm
- Versions : Fortimo DLM-Int (AC) 2000lm  
PrevaLED Cube (AC) 2000lm

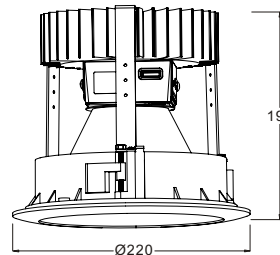
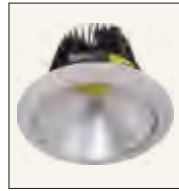

### LD10028-SLM

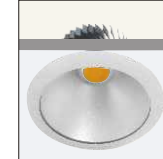

Fortimo SLM 2000lm

### LD10028-OR



PrevaLED Core 2000lm

### Intensity(unit:cd)

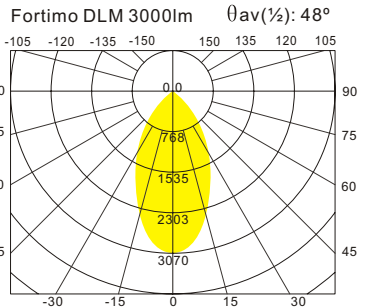

### LD8110

- Trim : Alum. Die Cast
- Reflector : High Purity Alum., Clear
- Diffuser : Clear Tempered Glass /  
Satin Acrylic Lens
- Bracket : Steel
- Heat Sink : Alum. Extrusion (Passive)
- LED Power : Fortimo DLM (DC) 2000lm  
Fortimo DLM (DC) 3000lm  
Fortimo DLM (DC) 5000lm
- Versions : Fortimo DLM-Int (AC) 2000lm  
PrevaLED Cube (AC) 2000lm  
PrevaLED Cube (AC) 3000lm



IP65 Version

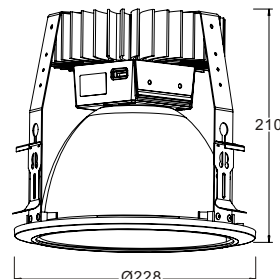

### LD8110-SLM

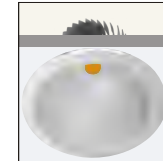

Fortimo SLM 2000lm

### LD8110-OR



PrevaLED Core 2000lm

### Intensity(unit:cd)

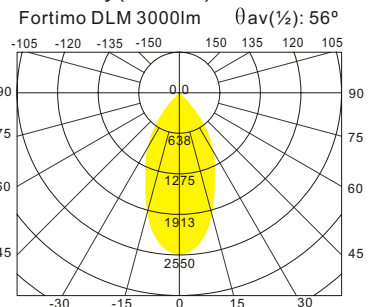

# LED Recessed Down light

## - Quartet

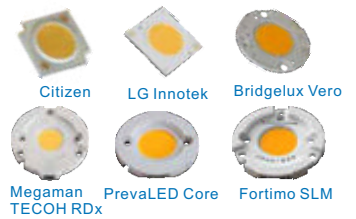

**LD3409**  
 Trim : Alum. Die Cast  
 Reflector : High Pure Alum.  
 Matt Anodized  
 Heat Sink : Alum. Extrusion  
 LED Power : Citizen 13W  
 Versions : Bridgelux Vero 10  
 PrevaLED Core Z3 1100lm  
 LG LEMWM11 28W  
 Megaman TECOH RDx

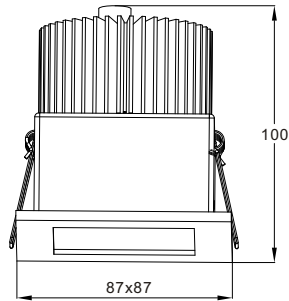
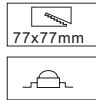

Intensity(unit:cd)

Citizen 13W

$\theta_{av}(\frac{1}{2})$ : 59°

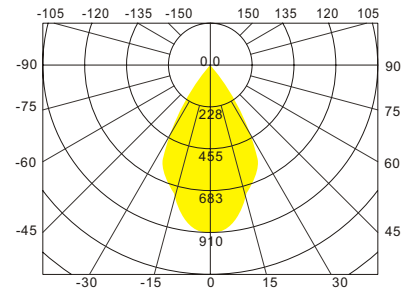

**LD4033-SLM**  
 Trim : Alum. Die Cast  
 Reflector : High Pure Alum.  
 Matt Anodized  
 Heat Sink : Alum. Extrusion  
 LED Power : PrevaLED Core Z3 1100lm  
 Versions : Citizen 13W  
 Bridgelux Vero 10  
 LG LEMWM11 28W  
 Megaman TECOH RDx

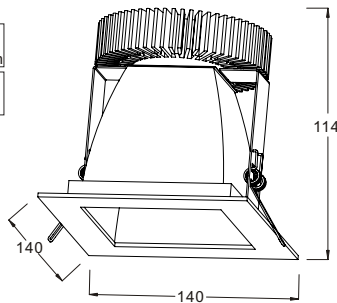

Intensity(unit:cd)

PrevaLED Core Z3 1100lm  $\theta_{av}(\frac{1}{2})$ : 66°

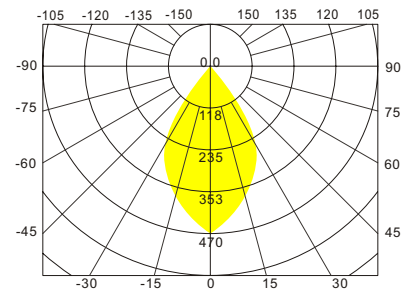

**LD6033-SLM**  
 Trim : Alum. Die Cast  
 Reflector : High Pure Alum.  
 Matt Anodized  
 Heat Sink : Alum. Extrusion  
 LED Power : PrevaLED Core Z3 2000lm  
 Versions : Citizen 28W  
 Bridgelux Vero 13  
 Fortimo SLM 2000lm  
 LG LEMWM11 28W  
 Megaman TECOH RDx

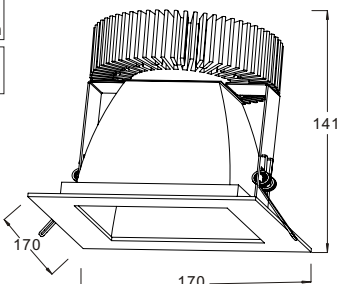
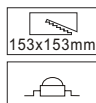

Intensity(unit:cd)

PrevaLED Core Z3 2000lm  $\theta_{av}(\frac{1}{2})$ : 68°

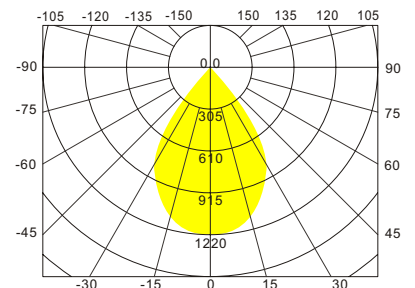

# LED Recessed Down light

## - Quartet



Fortimo DLM



PrevaLED Cube AC



### LD4044-DLM

Trim : Alum. Die Cast  
 Reflector : MIRO 5 / MIRO 4  
 Diffuser : Frosted Tempered Glass / without lens  
 Heat Sink : Alum. Extrusion  
 LED Power : Fortimo DLM 1100lm  
 Version : PrevaLED Cube AC 1100lm

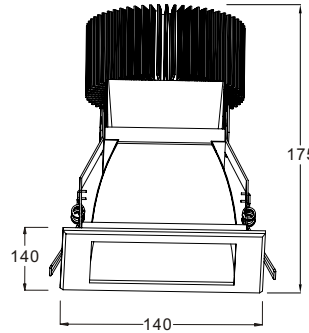

### Intensity(unit:cd)

Fortimo DLM 1100lm  $\theta_{av}(\frac{1}{2})$ : 68°

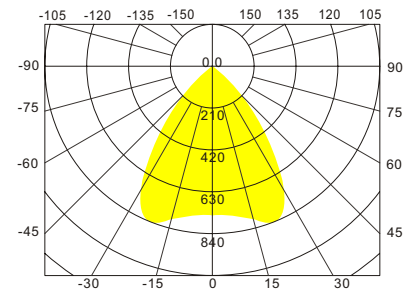

### LD8044-DLM

Trim : Alum. Die Cast  
 Reflector : MIRO 4 / MIRO 5  
 Diffuser : Frosted Tempered Glass / without lens  
 Heat Sink : Alum. Extrusion  
 LED Power : Fortimo DLM 3000lm / 5000lm  
 Version : PrevaLED Cube AC 2000lm

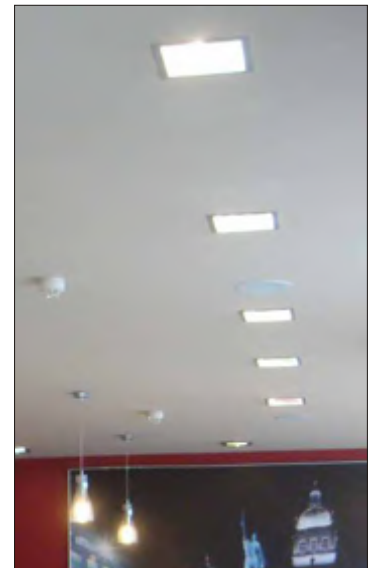

With Philips Xitanium 12 W driver fxd output	Light output lm	Module Power W	Module efficacy lm/W	System efficacy lm/W	CCT K	Tc life LED module °C
Fortimo LED DLM 1100 12W/830 Gen4	1100	12	94	75	3000	70
Fortimo LED DLM 1100 11W/840 Gen4	1100	11	103	82	4000	70

With Philips Xitanium 25 W driver fxd output	Light output lm	Module Power W	Module efficacy lm/W	System efficacy lm/W	CCT K	Tc life LED module °C
Fortimo LED DLM 2000 22W/830 Gen4	2000	22	91	78	3000	70
Fortimo LED DLM 2000 20W/840 Gen4	2000	20	100	86	4000	70

With Philips Xitanium 50 W driver fxd output	Light output lm	Module Power W	Module efficacy lm/W	System efficacy lm/W	CCT K	Tc life LED module °C
Fortimo LED DLM 3000 34W/830 Gen4	3000	34	88	77	3000	70
Fortimo LED DLM 3000 32W/840 Gen4	3000	32	94	82	4000	70

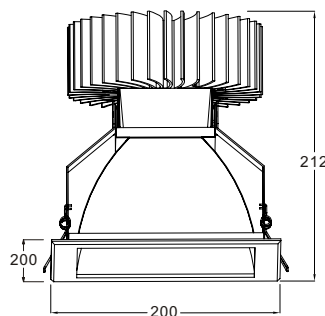

### Intensity(unit:cd)

Fortimo DLM 3000lm  $\theta_{av}(\frac{1}{2})$ : 66°

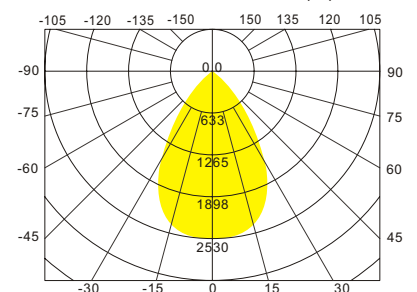

# LED Recessed Down light

## - IP 65 Twistable

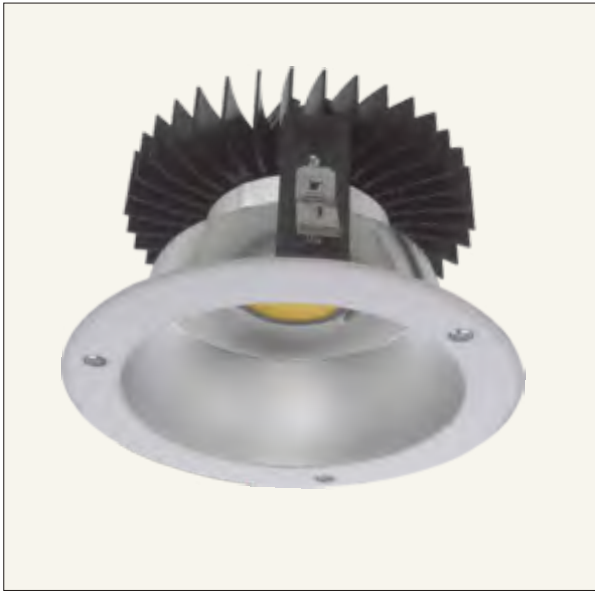
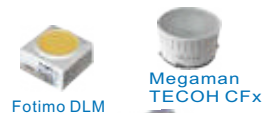

### LD6112-TB

Outer Trim : Alum. Die Cast  
 Reflector : High Pure Alum.  
                   Sand Blasting  
 Diffuser : Clear Tempered Glass  
 Heat Sink : Alum. Extrusion  
 Bracket : Steel  
 LED Power : Fortimo Twistable 1100lm  
 Versions : Fortimo DLM 1100lm  
                   PrevaLED Cube AC 1100lm  
                   Megaman TECOH CFx

Remark : Heat Sink NO. SK-C 165B



IP65

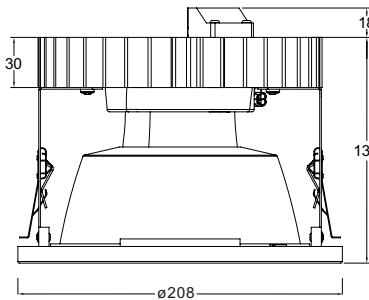
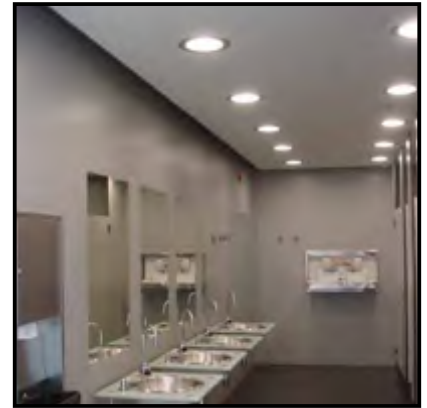

### Intensity(unit:cd)

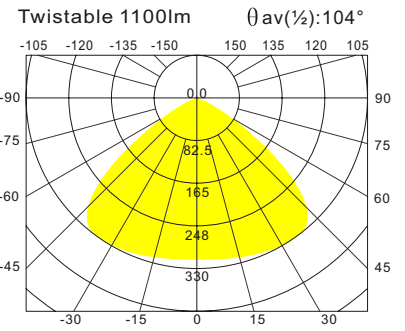

### LD8112-TB

Trim : Alum. Die Cast  
 Reflector : High Pure Alum.  
                   Sand Blasting  
 Diffuser : Clear Tempered Glass  
 Bracket : Steel  
 Heat Sink : Alum. Extrusion  
 LED Power : Fortimo Twistable 2000lm  
 Versions : Fortimo DLM 3000lm  
                   PrevaLED Cube AC 2000lm  
                   PrevaLED Cube AC 3000lm  
                   Megaman TECOH CFx

Remark : Heat Sink NO. SK-C 165B



IP65

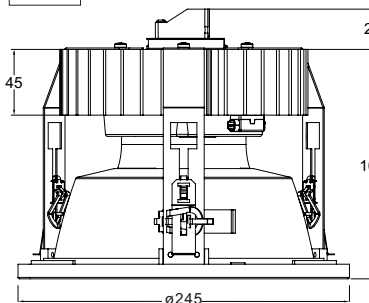

### Intensity(unit:cd)

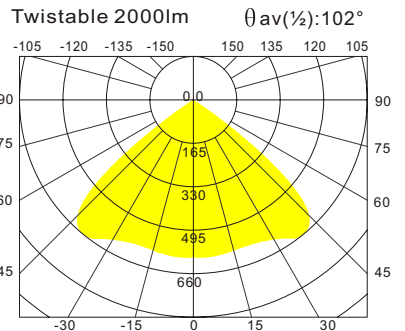

# LED Recessed Pulled Down light

## - Euro Star-P, TGV-P

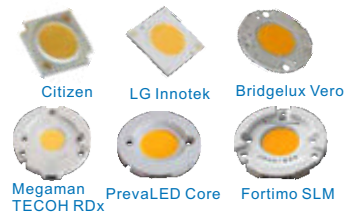

### LD5110

- Trim : Alum. Die Cast
- Reflector : Angle 10°, 24°, 36°
- Diffuser : Clear Tempered Glass
- Housing : Alum. Extrusion
- Heat Sink : Alum. Extrusion
- LED Power : Citizen 28W
- Versions : Bridgelux Vero 13  
PrevaLED Core Z3 2000lm  
Fortimo SLM 2000lm  
LG LEMWM11 28W  
Megaman TECOH RDx

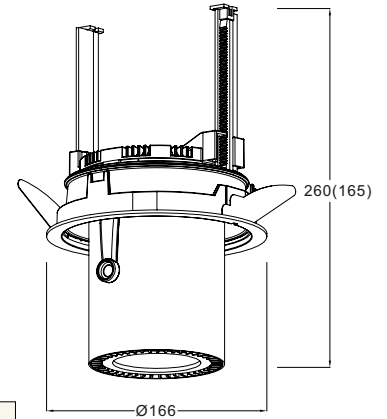
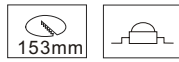

### LD5111

- Trim : Alum. Die Cast
- Reflector : Angle 10°, 24°, 36°
- Diffuser : Clear Tempered Glass
- Heat Sink : Alum. Extrusion
- LED Power : Citizen 28W
- Versions : Bridgelux Vero 13  
PrevaLED Core Z3 2000lm  
Fortimo SLM 2000lm  
LG LEMWM11 28W  
Megaman TECOH RDx

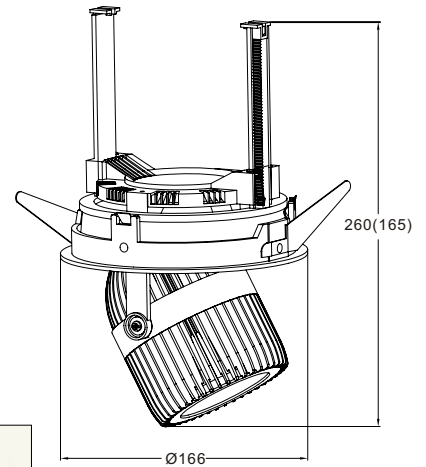

### Reflectors For Different Light Distributions

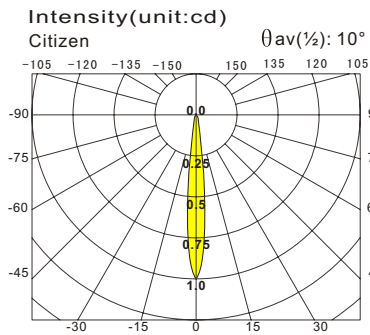

2201 (Narrow)

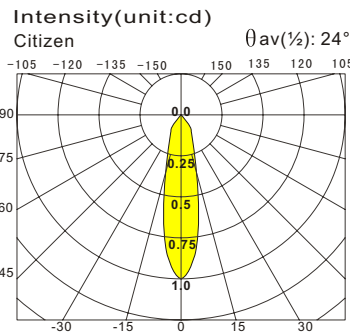

2207 (Medium)

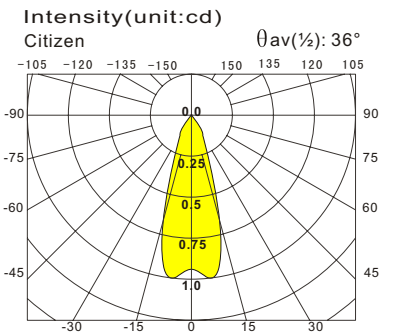

2202 (Flood)